

Windows & Doors by Internorm

Europe's No. 1 Window Brand



Nothing compares to

Internorm[®]
Windows – Doors

2024/2025

Timber-Aluminium Windows
Page 34



uPVC & uPVC-Aluminium Windows
Page 20



Internorm innovations
Page 10



Entrance Doors
Page 62

Lift & Slide Doors and Fixed Glazing
Page 52

Contents

COMPANY	4
Our Values	4
Production	6
Service	8
Warranty	9
INNOVATIONS	10
I-tec Technologies	12
WINDOWS	18
Design Styles	18
uPVC & uPVC-Aluminium Windows	20
Timber-Aluminium Windows	34
Windows with integrated Blinds	44
Lift & Slide Doors and Fixed Glazing	52
COMBINATIONS	60
ENTRANCE DOORS	62
Design Options	64
Door Systems	70
Door Series	72
Side Entrance Doors	106
Online Door Designer	108
FINISHES & ACCESSORIES	110
Colours	112
Handles	114
Glass	120
Juliet Balcony	122
Security	123
Sun Protection and Flyscreens	128
Technical Overview	134
Certifications	138





Internorm – Europe's No. 1 Window Brand

Internorm has been a family business for 93 years. Since its beginnings as a one-man locksmith, it has developed into the biggest window brand, operating on an international scale.

More than 29 million window and door units – 100% made in Austria – have so far made their way to new homes from our three production facilities in Traun, Sarleinsbach and Lannach. From the early beginnings of the uPVC window and the first timber-aluminium windows, to today's high-tech and contemporary design innovations, our family company still sets the standard across Europe and beyond. Our focus on continuous technological developments and innovative solutions has made us the pioneers of the fenestration industry.

We employ over **2,100 employees** throughout Europe, all of them specialists within their field, who work with dedication, creativity and attention to detail. Together with over **1,300 distribution partners in 21 countries**, we strive to deliver a quality product and competent customer service.

Now in the hands of the third generation, **Anette Klinger**, **Stephan Kubinger** and **Christian Klinger** are leading the company with a strong focus on stability and sustainability. Their drive and commitment to innovation ensures that the company continues to be the trailblazer within the window and door industry.

100% quality made in Austria – that's what we stand for.

Our experienced employees create your bespoke windows and doors in our three high-tech manufacturing sites in Austria, Train, Sarleinsbach and Lannach. Every window or door is unique.

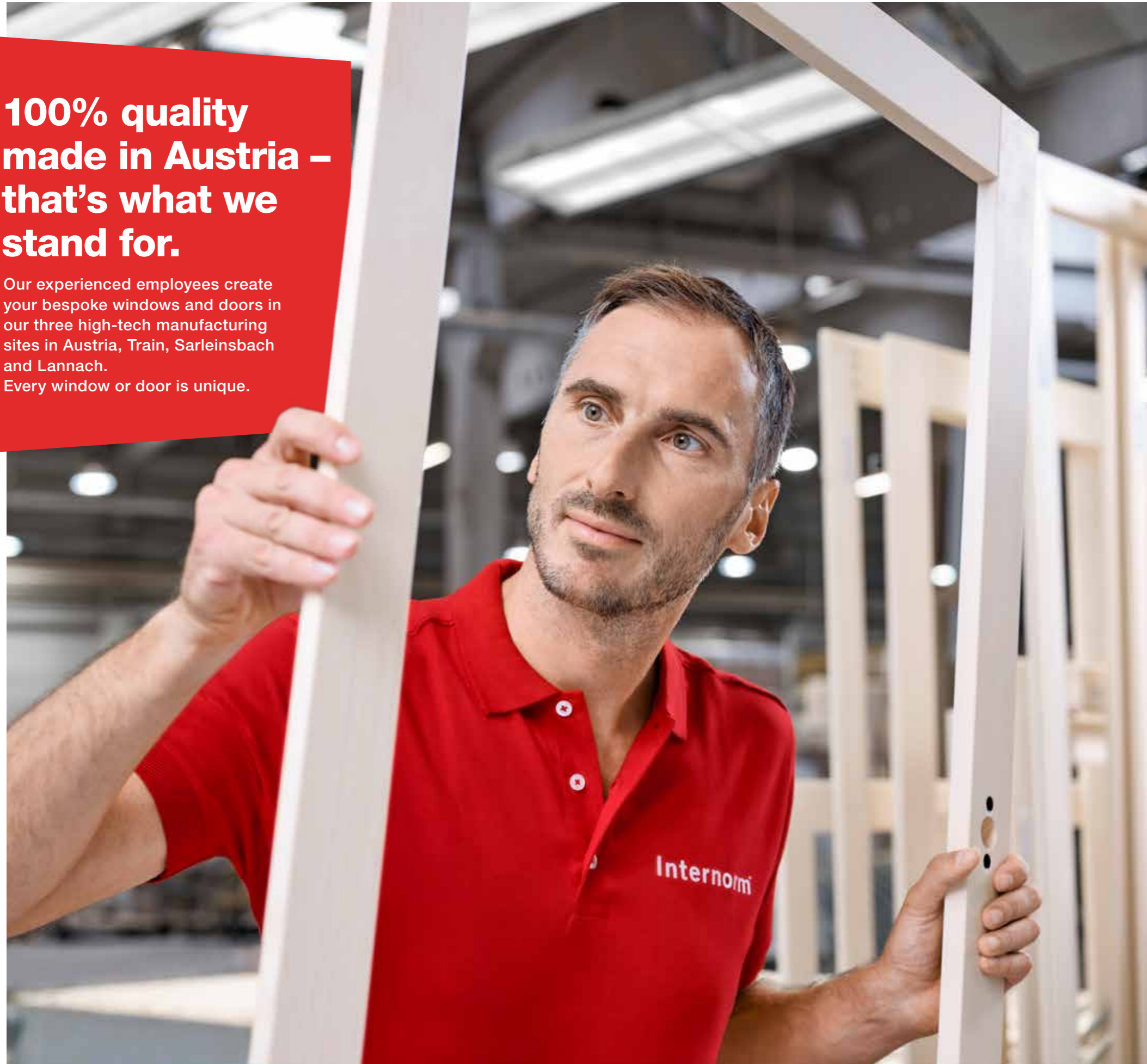

Outstanding quality is the result of our passion.



Our employees are specialists with an eye for detail, who carry out their jobs with passion and creativity. The company's own research department is continuously developing new products and technologies to provide you with even more comfort and security. Our production employees work with the greatest care to create quality products for modern living. We focus on sustainable, energy-efficient and safe production processes to ensure the preservation valuable resources.



A unique QR code on your windows and entrance doors

This reveals a special service to give your windows and doors a long life.

By scanning the QR code in the rebate of your window or aluminium entrance door, you will receive **useful information on your product**, helpful tips on cleaning, contact details for your responsible distribution partner, as well as a link to the online shop for maintenance products. To ensure the longevity of your windows and doors, your Internorm products require the **correct care and maintenance**. You can find all the relevant information on this as well as suitable replacement parts from the Internorm window service at www.fensterservice.com or from **your distribution partner**.



Our guarantee also demonstrates responsibility.

As the largest, leading European window brand, operating internationally, Internorm boasts over 93 years of experience and is focused on developing innovative, exceptionally high-quality and reliable window and door solutions. That's our guarantee.

Warranty

15
YEARS

- Against condensation between the sealed panes of insulating glass, if the glass is not heavier than 80kg.

Warranty

10
YEARS

- On weather resistance against unnatural change of colour and cracks in surfaces of:
 - white UPVC window and door profiles, except for mitre cracks.
 - inside foil covered UPVC window and door profiles, except for mitre cracks.
 - anodised (a form of metal coating) or powder coated aluminium window and door profiles.
- Against condensation between the sealed panes of insulating glass.
- On the glue connection of glued Georgian/feature bars.
- On the function of the material compound timber, thermal foam and aluminium profiles in timber aluminium composite products when adhering to the Internorm fitting and maintenance guidelines.
- On the function of the glued connection and sealing of the insulating glass panes with window profiles in timber aluminium composite products when adhering to the Internorm fitting and maintenance guidelines.
- Where goods are supplied with marine grade aluminium finish.

Warranty

5
YEARS

- For PVD coated entrance door handles against corrosion, if no mechanical damage is apparent.
- On weather resistance against unnatural colour changes or cracks in door filling surfaces.
- This 5-year warranty does not apply to the SD10 real-wood surface.

Warranty

3
YEARS

- On weather resistance against unnatural change of colour and cracks in surfaces of anodised or powder coated aluminium roller shutters, blinds and window shutter profiles.
- On the function of window and door hardware when the Internorm fitting and maintenance guidelines have been followed.
- On weather resistance against unnatural change of colour and cracks in surfaces of UPVC roller shutter profiles.

Guarantee

30
YEARS

Internorm guarantees that our Goods manufactured from 1999 onwards are capable of being repaired by our specialists in such a way that their full functionality is guaranteed to subsist or be retained over a time period of 30 years. However, this is subject to the construction (i.e. frames and sashes) remaining undamaged and subject to the customer paying our costs of repair, where applicable. The 30-year period begins with the Internorm production date, confirmation of which will be provided on request. The services or materials, labour time etc., necessary to retain functionality will be charged at respective current rates.

Warranties/excerpt: The full version of our warranty information, warranty requirements and how to make a warranty claim can be found in the Internorm Maintenance, Care and Warranties Manual.

This manual is delivered together with your Internorm products. It is also available as a PDF from the Download section of our website and from every **Internorm distribution partner**.



Our innovations

The innovative and modern windows and doors produced by Internorm combine technology, longevity and design in a very unique way.

I-tec Secure**I-tec Secure locking technology – state-of-the-art design meets maximum security**

Unrivalled, fully integrated locking mechanism up to resistance class RC 3



Smooth finish for a sleek look and easy cleaning

It's not just the people who surround us, but also the way we furnish our living spaces, and our view of the outside, that help us feel at home in our own four walls. A sense of security is another important component.

With the unrivalled I-tec Secure locking mechanism, you can rest assured that your windows offer reliable protection. Instead of the usual locking pins, flaps are used to precisely lock the window sash into the frame. It is virtually impossible to lever out the window.

I-tec Secure is integrated into our KF 510 and KF 520 premium-design windows as standard and is available up to resistance class RC 3 on request.



Learn more about our unrivalled I-tec Secure locking mechanism.



The flaps also offer considerable advantages when it comes to cleaning the windows. Only a few parts protrude from the sash, while the frame parts are concealed almost entirely, leaving a smooth, easy-to-clean uPVC surface.

I-tec Secure is integrated into our KF 510 and KF 520 window systems as standard, both in uPVC and uPVC-aluminium, reaching resistance class RC2N with an optional lockable handle.



Standard distribution of the I-tec Secure locking points

FACT|BOX

- Modern glass architecture due to slim sightlines
- An elegant appearance, as there is no visible hardware
- Optimum security up to RC 3 achieved by integrated flaps
- Virtually impossible to lever out the window
- Easy-to-clean window frame

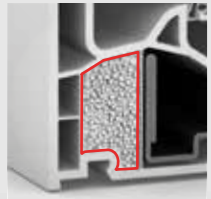
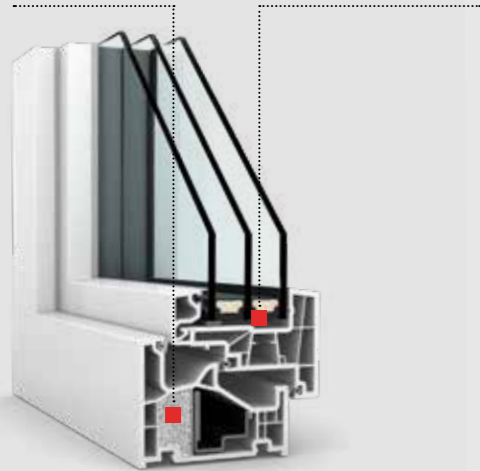
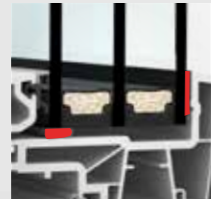
I-tec Insulation**I-tec Glazing****I-tec Core****I-tec Shading****I-tec Connect**

Scan here to find out more about I-tec Shading.

Our I-tec innovations

Under the title of **I-tec**, we've created a series of revolutionary and industry-leading innovations for windows and doors.

I-tec Insulation

Innovative window insulation

I-tec Insulation is included as standard with three Internorm window systems: the KF 410, KF 510, as well as our KV 440 windows with integrated blinds. Granulate is pushed into the frame's interior with pressure, thereby evenly filling the surrounding hollow chambers. This considerably improves thermal insulation.

I-tec Glazing

All-round gluing of glazing

I-tec Glazing technology provides maximum stability and security for your home. The glass pane is glued along the entire periphery of the window sash. This unique adhesive system guarantees firm bonding between glass and sash and considerably improves stability, thermal insulation and sound reduction.

I-tec Core

Strong windows made from natural materials

I-tec Core, made from thin, glued layers of timber, is incorporated into all our timber-aluminium systems (except HS 330 lift & slide door).

Exceptionally robust and durable, they allow the manufacture of larger windows. Another special feature of this innovation is that it exclusively uses timber obtained from sustainable forestry with a PEFC quality seal. As a result, we can offer you sustainable products created by resource-saving processing.

I-tec Shading**I-tec Connect**

Energy self-sufficient sun protection

With its photovoltaic module and back-up battery pack, I-tec Shading provides the ideal room temperature – it is completely self-sufficient, without requiring an additional energy supply.

When set to automatic mode, the Venetian blinds open and close automatically. Controlled by a built-in temperature sensor, it allows you to maximise the use of sunlight in winter, therefore reducing heating costs.

Daily convenience with I-tec Open

Simply knock to open – thanks to the modern day latch function for your entrance door.

Knock-knock

Knock twice on the outside of the door to unlock the door sash, and you'll be able to open the door without much effort – as easy as child's play. Knocking creates vibrations that activate the module, which is installed out of sight within the frame. You don't need to knock on a particular area of the door. The I-tec Open technology prevents the door from opening accidentally, for example by gusts of wind, as only knocking can create the required vibrations.

I-tec Open

FACT|BOX

- Easy activation using a push button (fingernail-friendly)
- Modern, electronic day latch function
- Children, weaker persons or even wheel-chair users can enter more easily and without great effort
- Unintended opening by a gust of wind or draft is not possible



A **green light on the switch** lets you know quickly and clearly whether the day latch is activated. If the light isn't on, this means that the module is deactivated and the day latch function is not in operation.

I-tec Open is **fully integrated into the door frame** and not visible from the outside.

Note: If I-tec Open is controlling the electric door opener (see ETOE, page 127) – the door may not be locked.

I-tec Decor

**The technology of the future
Digital printing now at Internorm**

New design options for maximum individuality

With the new I-tec Decor, the surfaces of your internal window profiles can be matched to your furniture, floors or doors. The new digital printing technology works in a similar way to an inkjet printer, allowing you to create a more personalised, unique home.

The I-tec Decor design is applied in multiple layers to the internal uPVC profile. An additional top coat provides protection against UV radiation and commercially available cleaning agents. With the new I-tec Decor digital printing technology, we can offer eleven distinct designs on the inside of KF 310, KF 410 and KS 430 systems, which will blend beautifully into your interior design.

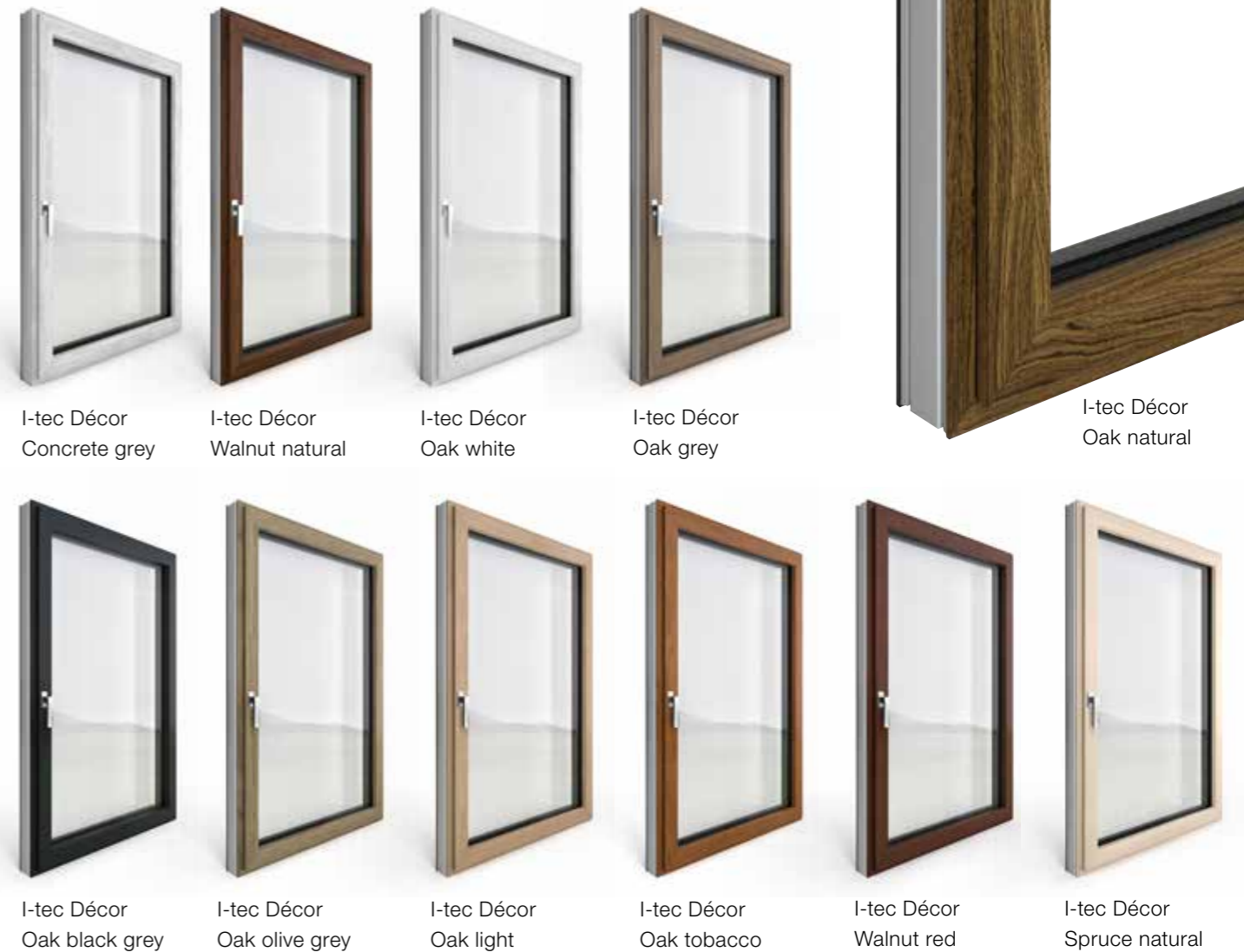

I-tec Décor
Concrete grey

I-tec Décor
Walnut natural

I-tec Décor
Oak white

I-tec Décor
Oak grey

I-tec Décor
Oak natural

I-tec Décor
Oak black grey

I-tec Décor
Oak olive grey

I-tec Décor
Oak light

I-tec Décor
Oak tobacco

I-tec Décor
Walnut red

I-tec Décor
Spruce natural

Details on colour and texture can be found in our colour overview (page 113).

FACT|BOX

- The exciting digital printing technology of the future
- Eleven different designs offer individual creative options
- Available as internal finish on uPVC for KF 310 and KF 410 windows, and KS 430 lift & slide door



studio

For design lovers with a passion for elegance.

The **studio** design style is characterised by clean lines and a minimalist design. Large glazing becomes a design feature in its own right, whilst enhancing exceptional architecture.



home pure

Simple, straight lines for classic designs.

The modern **home pure** window with its square edge design perfectly blends into the unique architecture of contemporary buildings.



home soft

Gentle curves for creating feature highlights.

The elegant round-edge design of a **home soft** window creates a sleek and timeless look that can be integrated effortlessly into any design and lends the architecture a particularly harmonious ambience.



ambiente

Classic detailing for timeless architecture.

An **ambiente** window offers the perfect blend of traditional design and classic detailing. The round profiled edges add a unique character to any facade.





Our uPVC & uPVC-aluminium windows

We develop and manufacture innovative windows that satisfy even the highest demands. Whether unrivalled protection against burglary, exceptional thermal insulation or outstanding noise protection – we place great value on meticulous processing down to the last detail.

Premium design

The KF 520 and KF 510 uPVC & uPVC-aluminium windows from Internorm



Standard uPVC-aluminium window Our slim KF 520

Particularly slim and modern thanks to slim sightlines, the increased areas of glazing allows for maximum light penetration and comfort of living.

The **highly weather-resistant aluminium coating** from Internorm increases colour stability.

I-tec Secure



The **fully integrated I-tec Secure locking system** not only provides maximum security, but also offers easy cleaning. This locking system is **only available from Internorm** and is integrated into the KF 520 and KF 510 windows as standard.



PREMIUM Design

The best of the best

Our premium-design windows offer an outstanding blend of state-of-the-art design and revolutionary security. Exceptional products that meet even the highest demands regarding architecture and design.

Internorm

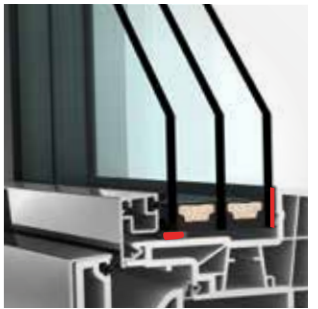

I-tec Glazing

The all-round bonding of the glass pane with the window provides **outstanding stability** and **protection against break-ins**. It also increases thermal insulation and sound reduction.



The **high-quality handles** are available in a number of options and colours. You'll find a suitable window handle for every design.



Three circumferential gaskets, made of high-quality, durable materials, keep water out and improve thermal insulation and sound reduction.

I-tec Insulation

The **insulating granules** are evenly distributed throughout the hollow chambers, thereby improving thermal insulation in our KF 510 and KF 410 window systems, as well as our KV 440 windows with integrated blinds.

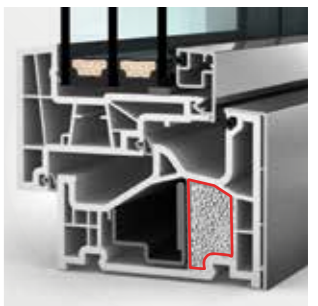

KF 520

uPVC & uPVC-aluminium windows



FACT|BOX

- For highly modern architecture: indistinguishable from fixed glazing
- Slim frames for even greater light penetration
- Only available from Internorm: unrivalled, fully integrated I-tec Secure locking mechanism up to resistance class RC 3

A perfect blend of design and technology



The **revolutionary I-tec Secure locking mechanism** makes it virtually impossible to lever the window – a unique feature in the industry. Upon locking, integrated flaps push onto the frame's interior on all four sides, thereby ensuring maximum burglary protection up to resistance class RC 3.

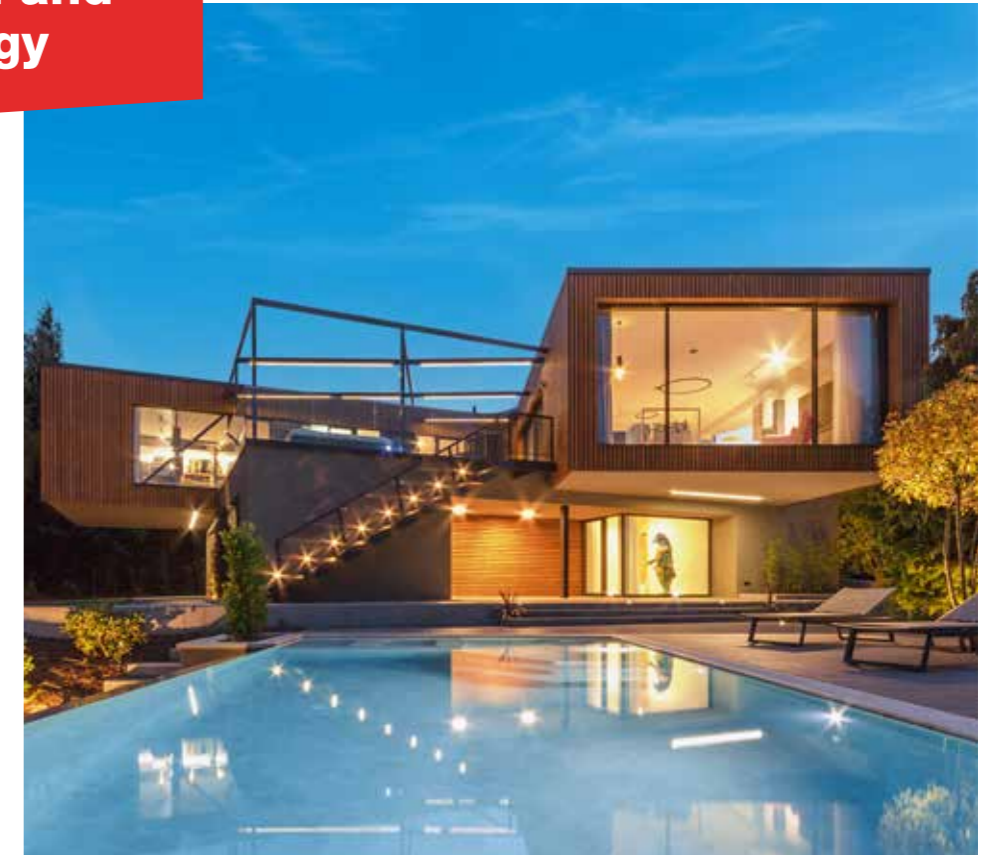

Thanks to **its frame design, the window sash isn't visible from the outside** and is indistinguishable from fixed glazing. In contrast to fixed glazing, the window can be opened, making this design perfectly suited to modern architecture. This window has won multiple awards for this unique feature.

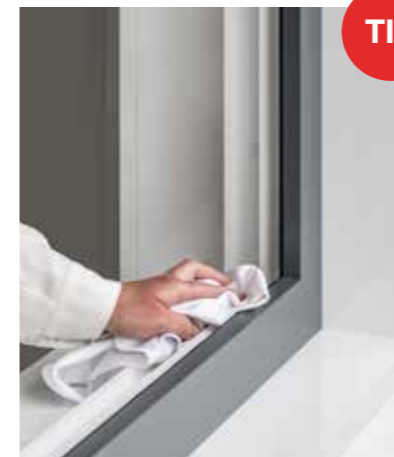

TIP

I-tec Secure flaps also come with clear advantages for window cleaning, as only a small number of parts protrude from the sash and frame parts are nearly non-existent.



studio

If you're looking for clean lines and a modern design, the KF 520 is available in the **flush-mounted design version studio**. For the exterior, you can choose between aluminium cladding or uPVC.

 **Thermal insulation**
U_w as low as = 0.63 W/(m²K)

 **Noise reduction**
up to 46 dB

 **Security**
up to RC 3

 **Locking**
fully integrated

 **Construction depth**
90/93 mm

I-tec Secure

I-tec Glazing

KF 510

uPVC & uPVC-aluminium windows



FACT|BOX

- Slim, modern frame with square design
- I-tec Secure locking system as standard up to RC 3
- Easy to clean thanks to locking flaps that are integrated into the sash

Maximum security and ideal for mix and match



When combined, I-tec Secure and I-tec Glazing offer maximum burglary protection. The fully integrated I-tec Secure locking system makes it particularly easy to clean.



The high proportion of glass – made possible by the slim frame of this window – lets even more daylight into your living area. Maximum security, a simple design and a **perfect match for the HF 510 timber-aluminium window** – the KF 510 is simply a great window.

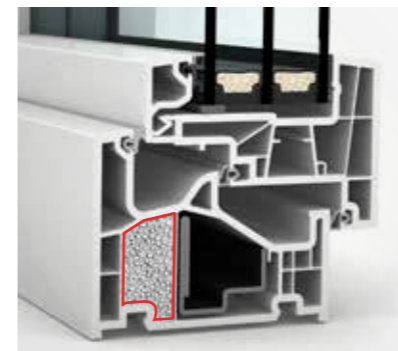

I-tec Insulation: The insulation granules are evenly filled throughout the hollow chambers, which improves thermal insulation and reduces energy costs.

home pure

The KF 510 window is exclusively available in the home pure design style and offers modern design. For the exterior, you can choose between an aluminium cladding or uPVC.

A perfect match

The KF 510 can be perfectly combined with the HF 510 timber-aluminium window (page 38). The external weather-resistant aluminium cladding is the same for both styles, creating a uniform appearance on the outside, whilst offering the choice of uPVC or timber options on the inside. You can tailor the windows to suit your individual requirements and create a harmonious interior design.



 **Thermal insulation**
U_w as low as = 0.63 W/(m²K)

 **Noise reduction**
up to 48 dB

 **Security**
up to RC 3

 **Locking**
fully integrated

 **Construction depth**
90/93 mm

I-tec Secure

I-tec Glazing

I-tec Insulation

KF 410

uPVC & uPVC-aluminium windows



FACT|BOX

- With four different design styles, we have a suitable option for every architectural style
- I-tec Decor technology offers customisation of the surface inside
- Optimal thermal insulation with I-tec Insulation

Versatile – suitable for all architectural styles



I-tec Glazing offers even more protection: The glass pane's all-round bonding with the window provides outstanding stability and burglary protection.

Whether flush, square, round or contoured – the KF 410 is our most versatile window, available in all four design styles and incorporating Internorm's unique I-tec technology. I-tec Insulation offers significant improvement in thermal insulation by completely filling the frame cavity. I-tec Glazing provides increased stability and improved security for your home.

studio home pure home soft ambiente

The KF 410 window is available in all Internorm design styles: flush, square, rounded or contoured – whatever your personal preference. On the outside, you can choose between aluminium cladding or standard uPVC (KF 410 in studio design style is only available with external aluminium cladding).

TIP

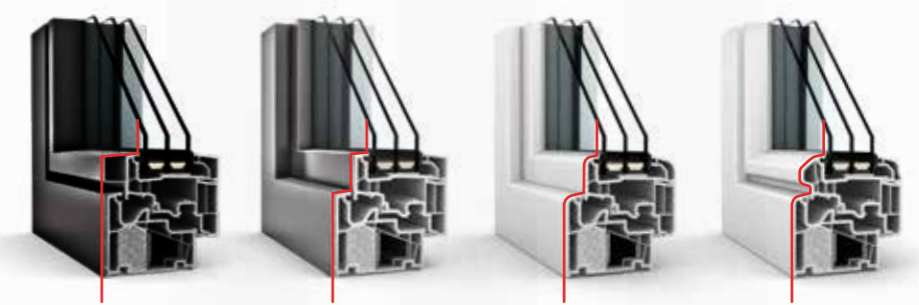
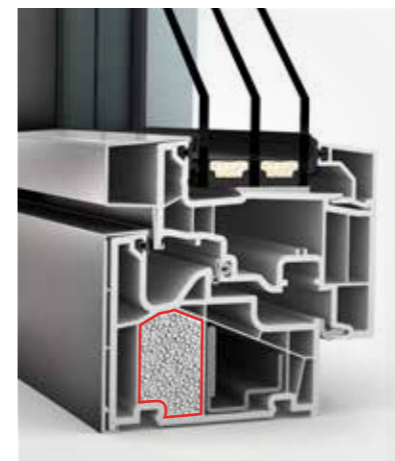

flush square rounded contoured

I-tec Insulation: The insulation granules are evenly filled throughout the hollow chambers, which improves thermal insulation and reduces energy costs. A benefit for the environment and your budget.

- | | | |
|---|---------------------------------------|-------------------------|
| Thermal insulation
U _w as low as = 0.62 W/(m ² K) | Locking
Concealed | I-tec Glazing |
| Noise reduction
up to 47 dB | Construction depth
90/93 mm | I-tec Insulation |
| Security
up to RC 2 | | I-tec Decor |

KF 320

uPVC & uPVC-aluminium windows



FACT|BOX

- A modern window with slim sightlines
- From the outside, the glass sash looks like fixed glazing
- All-round bonding with I-tec Glazing and good security as standard

Slim and stylish for modern architecture



The external sash does not have a visible uPVC frame and **therefore looks like fixed glazing** – but is actually an opening window.



The innovative glass sash of the KF 320 gives the impression of fixed glazing. Whether you opt for the classic uPVC version in white or add an aluminium cladding – the slim, square window frame enhances the minimalist architecture of the studio design style.

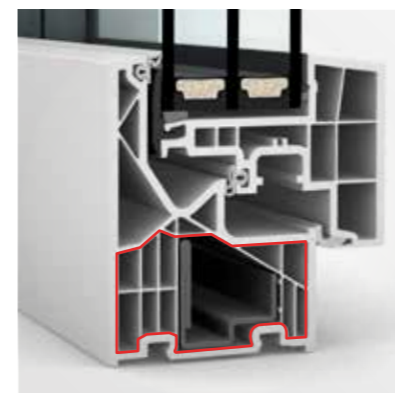

The 6-chamber frame profile provides improved thermal insulation. Triple circumferential gaskets protect the interior from moisture and at the same time improve thermal insulation and noise reduction. I-tec Glazing, the all-round bonding of glass to frame, provides outstanding stability and security.





studio

Available in the modern, flush **studio design style**

TIP

By rendering the window frame on three sides, you can create a **virtually frameless window solution.**

 **Thermal insulation**
U_w as low as = 0.65 W/(m²K)

 **Noise reduction**
up to 45 dB

 **Security**
up to RC 2

 **Locking**
Concealed

 **Construction depth**
71/74 mm

I-tec Glazing

KF 310

uPVC & uPVC-aluminium windows



FACT|BOX

- Low construction depth and slim sightline
- Excellent thermal insulation and noise reduction values
- All-round bonding and good security as standard
- I-tec Décor – for individual design options

Proven quality with excellent performance



The KF 310 is available as uPVC or uPVC-aluminium window in **three design styles**.



Developed by our experienced in-house product development team, the KF 310 features tried and tested technologies – outstanding thermal and sound insulation, combined with I-tec Glazing, the all-round bonding of the glass pane to the window sash.



A slim window, with a **construction depth of 71 mm** (74 mm with aluminium cladding).

home pure home soft ambiente

Available in three design styles to match your building style

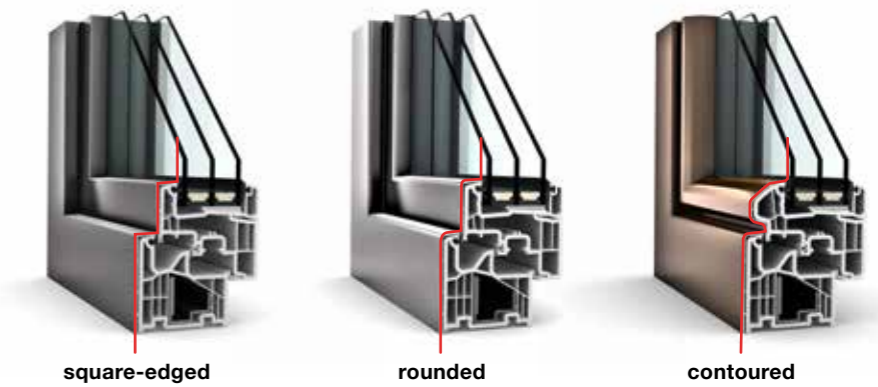

- | | | |
|---|---------------------------------------|----------------------|
| Thermal insulation
U _w as low as = 0.69 W/(m ² K) | Locking
Concealed | I-tec Glazing |
| Noise reduction
up to 45 dB | Construction depth
71/74 mm | I-tec Decor |
| Security
up to RC 2 | | |



Our timber- aluminium window for individual comfort in your home

With our range of design styles, you can tailor your new timber-aluminium windows to suit your home. Further personalisation can be achieved: hundreds of colours available for the external aluminium cladding, a range of beautiful internal timber options, as well as a choice of window handles.

What our timber-aluminium windows have to offer

The innovative timber-aluminium composite windows from Internorm

Particularly slim and modern due to a slim sightline – maximum glass for increased light transmission and improved living comfort.



Independent of timber type, the unique **timber-thermal foam-aluminium** bonding offers outstanding thermal insulation within a low construction depth.



I-tec Glazing

The glass pane's all-round bonding with the window frame provides **exceptional stability** and **burglary protection**. This technology is integrated into all our timber-aluminium systems as standard.



I-tec Core

The **I-tec Core** makes these windows **particularly robust and durable**, enabling larger window solutions. The exceptionally strong, glued wood layer construction, makes our timber-aluminium windows more durable and stable. **I-tec Core** is incorporated into **HF 410, HF 510**, as well as **HV 450** with integrated binds.



Internorm

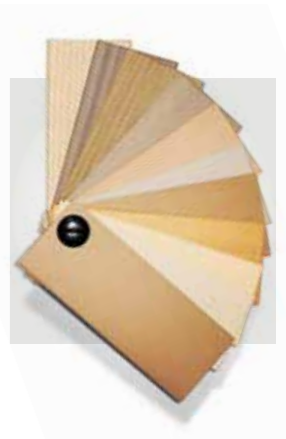

The **many different colours and types of timber** offer you countless options to personalise the colour schemes of your interior spaces, beautifully coordinating the windows with your interior design.

The perfect combination: Mix and match timber-aluminium windows with our uPVC-aluminium windows. The external weather-resistant aluminium cladding is the same for both styles, creating a uniform appearance on the outside, whilst offering the choice of timber options or uPVC on the inside. So you can opt for uPVC-aluminium for your bathrooms and timber-aluminium for all other rooms.



The durable and low maintenance external aluminium cladding is available in a wide choice of colours. Also choose from textured or wood effect finishes. For aluminium colour options see page 112.

Please note that not all options are available for all window systems. HF 510 is pictured here.

HF 510

Timber-aluminium windows



FACT|BOX

- The slimmest of our timber-aluminium windows for even more daylight
- Minimalist and modern design coupled with the natural look of timber
- Maximum design freedom and ideal combination options

Internorm

Combining modern design with a natural finish



The slim sightlines of the HF 510 timber-aluminium window provide a modern solution – maximum glass for increased light transmission and improved living comfort. Why not match this window with the HS 330 lift & slide door, available with the same timber options?



This window meets the **most demanding requirements in design** – slim, modern and elegant. It can easily be combined with our KF 510 uPVC-aluminium window in one project – the external aluminium cladding will match perfectly, creating a seamless, uniform look.



home pure

The modern, square design perfectly aligns with the requirements of contemporary architecture. With the internal choice of timber finishes, combined with the external, hard-wearing aluminium cladding, the HF 510 offers a wide range of design options to suit your project.

A perfect match

The advantage of the Internorm window systems is that whatever material you choose on the inside – natural timber or contemporary uPVC – the outside will always look the same. Combining the HF 510 timber-aluminium with the KF 510 uPVC-aluminium window (page 26) means that you can coordinate your internal materials with your individual room requirements without losing the harmonious appearance on the outside.



 **Thermal insulation**
U_w as low as = 0.65 W/(m²K)

 **Noise reduction**
up to 44 dB

 **Security**
up to RC 2

 **Locking**
Concealed

 **Construction depth**
85 mm

I-tec Core

I-tec Glazing

HF 410

Timber-aluminium windows



FACT|BOX

- I-tec Core provides high stability and strength
- Many types of timber, surfaces and colours to choose from
- Can be optimally adapted to suit your interior design

Natural all-rounder for any building requirements



The unique I-tec Core technology with thin, glued layers of timber in the frame and sash – for even larger window dimensions. You can also easily combine this window with our HX 300 fixed glazing.



Windows and large areas of glazing have become an essential feature of modern architecture. The selection of colours and materials for floors and furniture plays a crucial role in creating a harmonious overall feel – so you can design your individual living environment. The wide range of colour and timber options for the HF 410 offers countless possibilities to fashion your living space in a unique way – no matter the building style.

studio home pure home soft ambiente



The HF 410 is available in all design styles, meaning it can be perfectly combined with any architectural style.

TIP

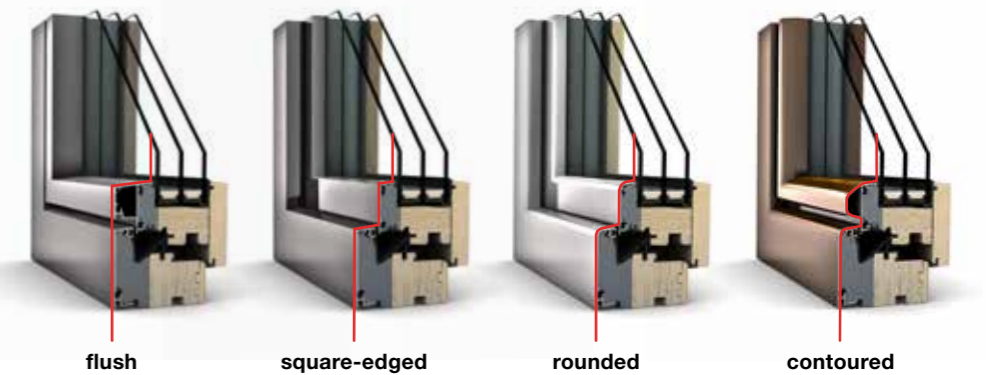

The timber-thermal-foam-aluminium bonding offers outstanding thermal insulation at a low construction depth, resulting in energy cost savings.

- Thermal insulation U_w as low as = 0.65 W/(m²K)
- Noise reduction up to 45 dB
- Security up to RC 2
- Locking Concealed
- Construction depth 85 mm
- I-tec Core
- I-tec Glazing

Case Study

Passivhaus certified self build with stunning views

Supply and Installation by Internorm partner Spectrum Architectural Glazing



“ Having decided on building not only to Passivhaus standard but also achieving certification, the windows and doors were a key factor in achieving this goal.”



An old bungalow made way for a stylish, Passivhaus certified home

An old bungalow, which occupied this large plot, was demolished to make way for this three-storey contemporary, energy-efficient Passivhaus certified newbuild with high ceilings and a beautiful open staircase.

To make the most of the stunning views over the garden and the Yorkshire countryside, 14m of fixed timber-aluminium glazing was installed on one side of the building on the upper level. Light from the large glazing fills the contemporary open plan living and dining area, creating a calm and bright space.

“We were introduced to Internorm at the design stage through the architect. The design of the windows was fairly advanced in terms of the products that we were looking for, but once we got involved with Spectrum, we did make a few adjustments to the specification based on their recommendation. We chose the timber-aluminium range in Ash for the windows, lift & slide doors and Panorama glazing throughout. Their involvement, especially with the large north-facing window, was important.”

“ We wanted to make the most of the stunning view, which we achieved with this incredible 14m stretch of fixed timber-aluminium glazing.”



Watch their full Case Study Video



Perfect for a renovation – our windows with integrated blinds

Internorm windows with accessible integrated blinds are unique within the fenestration industry. The blind, housed between window panes, is protected from wind, rain and dirt.

What our windows with integrated blinds have to offer.

Outstanding protection in one window.

I-tec Shading

Sun protection



I-tec Shading creates the perfect room temperature. With its photovoltaic module and back-up battery, it is completely self-contained, without the need for an additional energy supply. When set to automatic mode, the Venetian blinds open and close automatically at sunrise or sunset. This is controlled by built-in sensors, which means that you can make the most of the sunlight in winter, with the Venetian blinds fully open.

A choice of uPVC and timber is available for the inside.



Screen

Internorm offers integrated blinds with both uPVC-aluminium and timber-aluminium composite systems. You can choose from three blind options – Venetian, Roman or Duette black-out blinds. So whatever blind you choose, it will be completely protected from the elements due to its location within the sealed glass panes.



Duette®



Roman blind



TIP
For renovators: Windows with integrated blinds are ideal for renovation projects, as there is no need for separate sun protection. They are also a great solution for facades where shutters are not permitted.

Easy operation



Easily control your Venetian blinds on the window.

I-tec Insulation I-tec Glazing

Thermal insulation and noise reduction

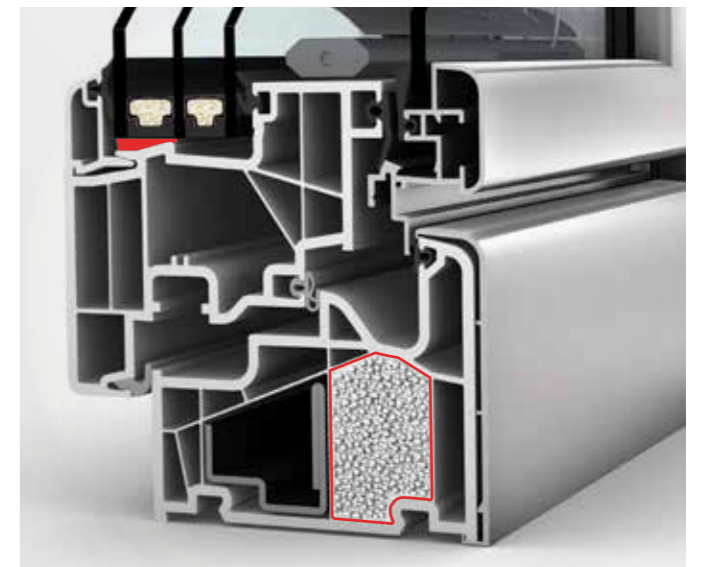

The insulation granules evenly fill the hollow chambers, which improves thermal insulation and reduces energy costs. In addition, the windows with integrated blinds offer improved noise reduction, so noise from the outside stays outside.

Please note that not all integrated blind options are available with all window systems.

KV 440

uPVC-aluminium windows with integrated blinds



Self-sufficient: The I-tec Shading option is powered by sunlight via a photovoltaic module, therefore not requiring an external power source.



I-tec Glazing ensures firm bonding between glass and sash, which also provides increased stability, improved thermal insulation and noise reduction.

home pure home soft ambiente

Select the design style to suit the design of your house.

KV 350

uPVC-aluminium windows with integrated blinds



The **6-chamber frame profile** provides **improved thermal insulation**. Triple gaskets protect the interior from moisture whilst at the same time improving thermal insulation and noise reduction.







With a construction depth of 74 mm, **this window is ultra-slim**. You can also perfectly combine it with the **KF 310 uPVC-aluminium window**.





home pure ambiente

For this window you can choose between the **home pure** and **ambiente** design styles.



-  **Thermal insulation**
U_w as low as = 0.64 W/(m²K)
-  **Noise reduction**
up to 45 dB
-  **Security**
up to RC 2
-  **Locking**
Concealed
-  **Construction depth**
93 mm

I-tec Connect **I-tec Insulation**
I-tec Glazing **I-tec Shading**

-  **Thermal insulation**
U_w as low as = 0.79 W/(m²K)
-  **Noise reduction**
up to 44 dB
-  **Security**
up to RC 2
-  **Locking**
Concealed
-  **Construction depth**
74 mm

I-tec Connect **I-tec Shading**
I-tec Glazing

HV 450

Timber-aluminium windows with integrated blinds



FACT|BOX

- Blinds sit between the window panes
- Sun and privacy protection, as well as thermal insulation and noise reduction in just one window
- Many types of timber, finishes and colours to choose from

Quadruple protection in just one window



With **perfect sun and privacy protection, as well as thermal and noise reduction**, you can enjoy quadruple protection in just one window. I-tec Shading works entirely without an external power source and also offers many useful features such as temperature sensors and day/night recognition.

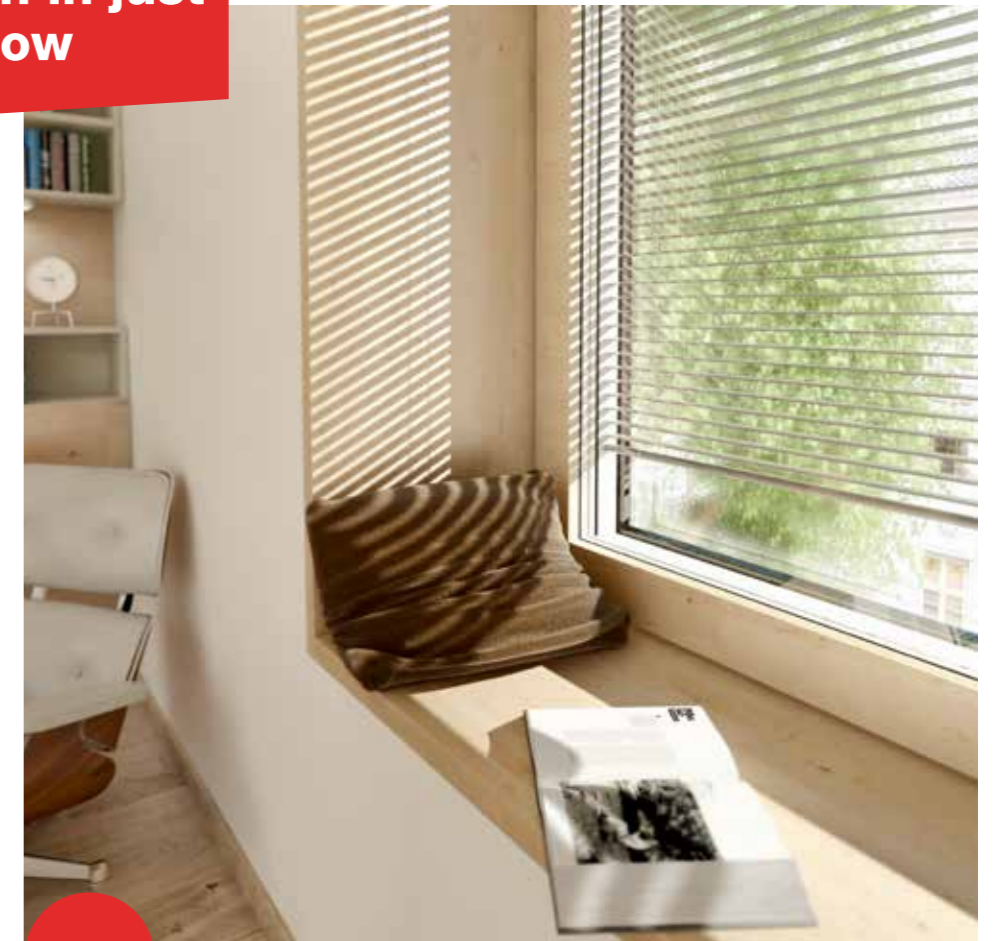

TIP

Our windows with integrated blinds can **easily be combined with our other windows.**



Thanks to the **I-tec Core**, these **windows are especially robust and durable**, enabling very large window solutions. In addition, the integrated I-tec Core made of timber is both **resource-saving and sustainable.**



home pure | home soft | ambiente

To match your building style, the HV 450 offers a suitable option in **home pure, home soft and ambiente.**

The blind offers sun protection and privacy, and is integrated between the panes. This not only comes with advantages for cleaning, but also protects the material from the elements.

- Thermal insulation U_w as low as = 0.62 W/(m²K)
- Noise reduction up to 46 dB
- Security up to RC 2
- Locking Concealed
- Construction depth 85 mm
- I-tec Connect
- I-tec Core
- I-tec Glazing
- I-tec Shading



Lift & slide doors and fixed glazing – for limitless freedom

Modern architectural glazing creates a new style of living. Large glass surfaces extend the living space beyond its actual limits. Internorm offers lift & slide doors and large fixed glazing to extend this feeling of freedom.

KS 430

uPVC & uPVC-aluminium lift & slide door

FACT|BOX

- Slim sliding door frame and frameless side elements with 3-sided rendering
- Inside can be customised with I-tec Decor technology
- Soft close handle for smooth handle return included as standard



More light with large elements
up to 650 x 280 cm and sashes up to 400 kg possible

ESG (toughened safety glass) as standard to prevent injury.

The low threshold makes passing through convenient, making the system ideal for barrier-free construction.

- 🔥 Thermal insulation
 U_w as low as = 0.64 W/(m²K)
- 🔊 Noise reduction
up to 43 dB
- 👐 Security
up to RC 2

I-tec Decor



I-tec Connect

Comfort Drive – allows your lift & slide door to be opened via electric operation. Can be integrated into a Smart Home system.



The KS 430 is **available as a uPVC or uPVC-aluminium option** – can be perfectly combined with your windows.

HS 330

Timber-aluminium lift & slide door

FACT|BOX

- Highly energy-efficient: Fibreglass threshold for optimum thermal insulation
- Frameless glazing achieved with fully rendered fixed elements
- Easy to lift and slide up to 400 kg sash weight

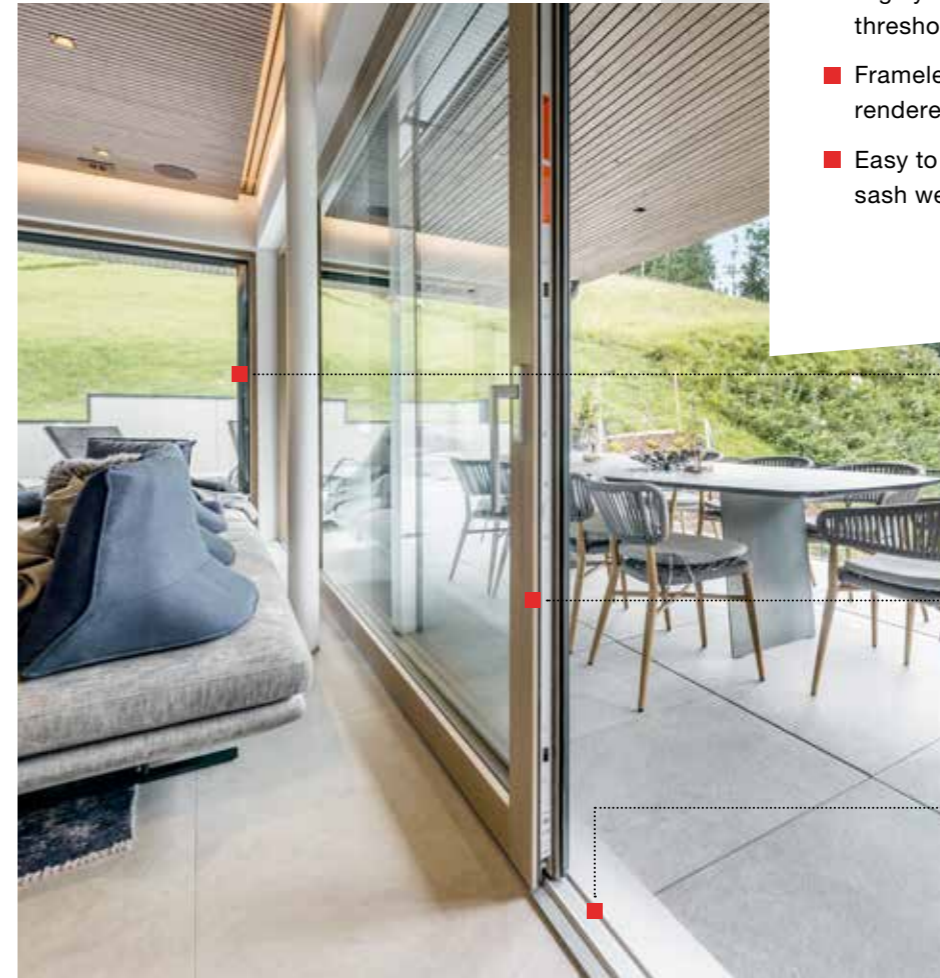

In combination with fixed glazing for even bigger glass surfaces; frameless glazing through fully rendered fixed element

Stylish colour options for personal design choices – can be perfectly combined with the timber-aluminium windows HF 410, HF 510 and HV 450.

The fibreglass, easy to clean threshold is covered with anodised aluminium on the outside, **providing optimal stability.**



I-tec Connect

Comfort Drive – allows your lift & slide door to be opened via electric operation. Can be integrated into a Smart Home system.



- 🔥 Thermal insulation
 U_w as low as = 0.73 W/(m²K)
- 🔊 Noise reduction
up to 47 dB
- 👐 Security
up to RC 2

I-tec Glazing

The glass pane is bonded on all four sides to the frame, providing **outstanding stability** and **burglary protection**. Integrated as standard in all our timber-aluminium windows and doors.

HX 300

Fixed glazing

This large-scale glazing can be fully integrated into the brickwork, creating a stunning frameless design feature for your home. Innovative glass joints create a near invisible transition between glass panes, therefore providing many options for modern, large-scale architectural glazing. HX 300 panoramic glazing is available with glass surfaces of up to 10.5 m², making the frame disappear almost entirely into the facade.

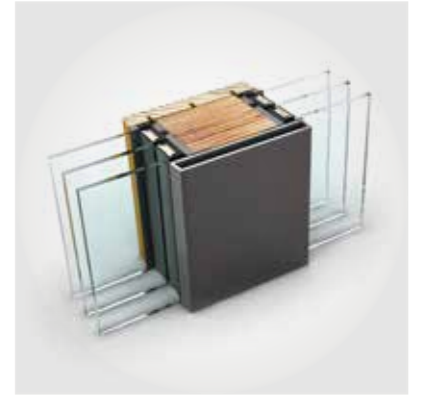

You can create **visual features** with integrated windows.

The **strong frame construction, glued with multiple layers**, enables a glass surface of up to 10.5 m².

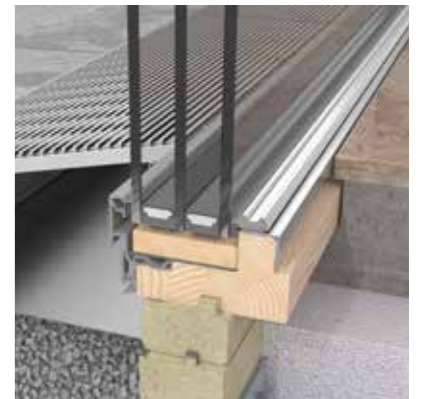

HX 300 offers the **optimal construction connection** for floor to ceiling glass surfaces.





The slim glass joint allows for large expanses of glass.



I-tec Glazing

Triple security glazing with I-tec Glazing as standard. The glass pane is continuously glued to the frame on all four sides, which guarantees a firm bond and exceptional stability.

 **Thermal insulation**
U_w as low as = 0.74 W/(m²K)

 **Noise reduction**
up to 47 dB

FACT|BOX

- Open and bright: glass joints are nearly invisible
- Large-scale glazing possible
- Frame disappears almost entirely into the facade

Case Study

Transformative retrofit into an energy-efficient, sustainable home

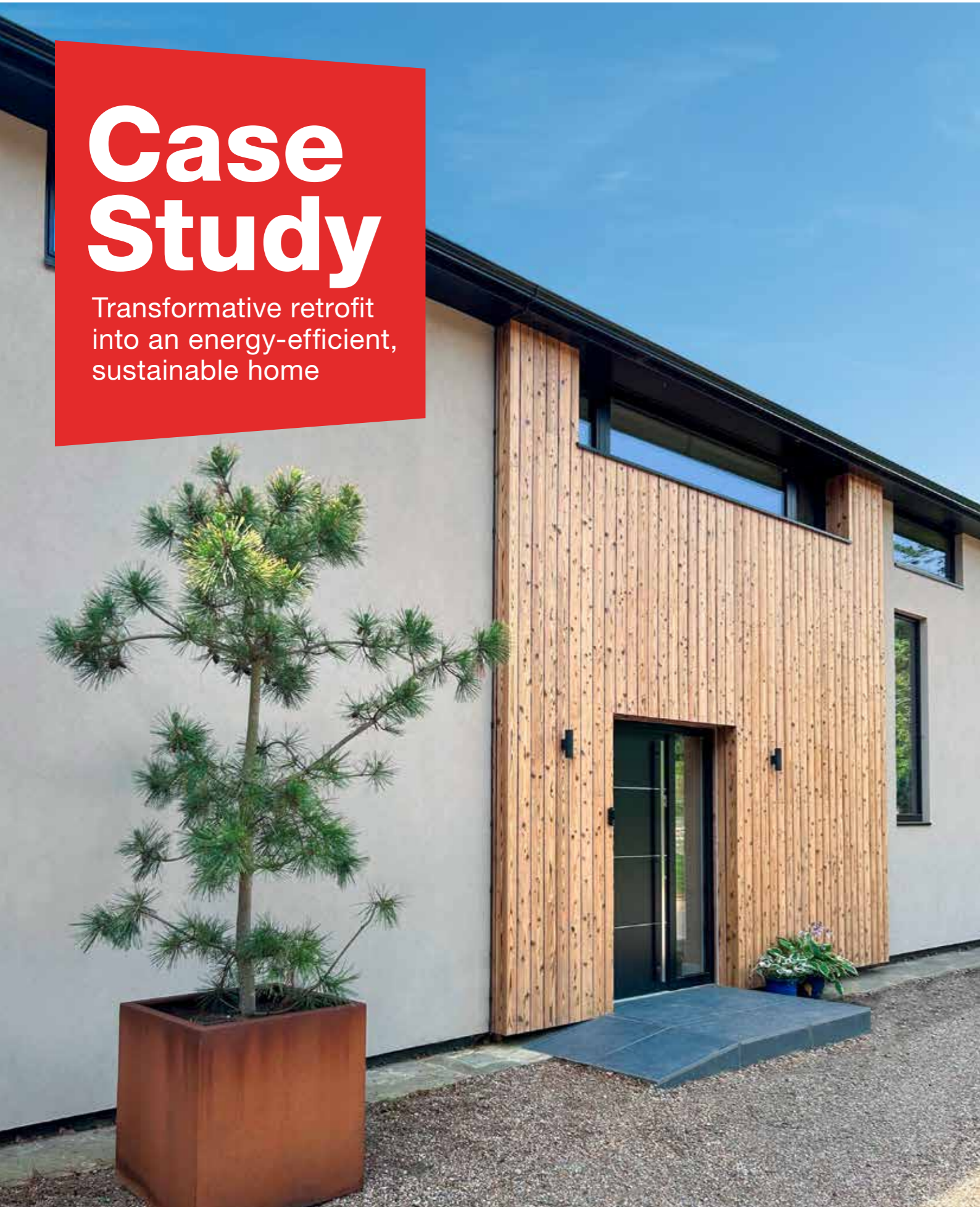

“ We love the oak interior finish of the windows. They frame the views beautifully in all directions. Whatever the weather or season, the outside looks like an ever-changing painting”.



A new lease of life for a run-down 1960s house

Sitting on top of a hill overlooking the beautiful Kent countryside, it was clear why the owners fell in love with this property. However, the house they encountered during their initial viewing was a neglected 1960s building, with leaking roofs and poorly insulated walls, windows, and doors. It needed complete refurbishment to bring it into the 21st century.

The homeowners spent a long time researching windows and doors. When they compared the thermal performance and cost of other brands to Internorm, they realised that there was no comparison and contacted Internorm distribution partner AT-Eco.

“Living with our Internorm windows and lift & slide doors is a joy! Being on an exposed site, the robust quality of the products means that during fierce winter storms and horizontal rain, our home is quiet, warm, and secure. There are no air gaps to worry about.”

Choosing quality products and local suppliers were important factors in their decision making. They did not seek Passivhaus certification but wanted to renovate to Passivhaus standard to create a green, sustainable home that stood the test of time.

“ It feels like a real home. I wanted this house to reflect our personalities and tastes. Quite often, we just sit on the sofa, watch the evenings draw in and just enjoy the amazing view.”



Watch their full Case Study Video

Internorm – as varied as your dream home

Windows, large-scale glazing such as lift & slide doors and entrance doors – at Internorm, you get everything from a single source – **100% made in Austria** and with reliable quality.

You can easily combine our timber-aluminium windows with our uPVC-aluminium windows. The aluminium cladding can be designed to match, thereby creating a uniform look for the exterior.

If you need a uPVC-aluminium window for your bathroom or wetrooms to match the timber-aluminium windows in your living room, no problem. There are many combinations for you to select. From the hundreds of colours for the external aluminium cladding, to timber options and uPVC Decor colours internally, as well as a range of window handles – the choice is yours. Create your dream home the way you envision it.



Timber-aluminium

Beautiful natural timber offers warmth, provides a pleasant atmosphere, and is ideal for living rooms and bedrooms.



uPVC-aluminium

uPVC is durable, exceptionally low-maintenance and thereby perfectly suitable for rooms with high humidity, e.g. bathrooms.



Lift & slide doors

Our lift & slide doors, combined with fixed glazing, offer the ultimate sense of space, flooding your home with natural daylight and creating a seamless transition for indoor/outdoor living.

Sun protection and flyscreens

To avoid overheating, it is important to include shading. Our range of sun protection, and fly screens, provides a comfortable living space.



Entrance doors

Expect the same high standard from your Internorm entrance door. Available in aluminium and timber-aluminium, you can choose from flush, ultra-modern to traditional, and create a secure entrance that reflects your taste.





Our entrance doors

Every Internorm entrance door is unique – individual and timeless.

Whether you choose one of our aluminum or timber-aluminium door systems, there is a wide range for stunning designs and accessories to suit your requirements and taste.

The entrance door – as unique as you

Each bespoke Internorm entrance door is manufactured to your individual requirements. The result is a unique door that is perfectly suited to you and your home.

To help you choose your perfect entrance door, you will find a selection of models and options on the following pages. With a wide range of colours, finishes, handle and glass options, you can give your door a personal touch. Create an impressive entrance that not only matches the style of your house, but also reflects your personality.

Why not take advantage of our online **Door Designer** tool for even more options? Design and customise your entrance door exactly how you want it. Or let our Internorm **1st window partners** advise you.



For the inside, choose from many different colours and finishes (page 112/113), as well as interior design options (page 119).

A wide range of colours, designs and materials is available for the outside (page 112).

Smart access control systems are available on request (e.g. fingerprint scanners, page 126/127)

Every door is also available with the option of side lights and/or fanlights.

Structural, design and motif glass (page 120/121)

Handle options at a glance (pages 116 – 118)

Model details

Designation
FA
 Colour:
 Handle:
 Glass:
 Order No.:

Order number of the depicted door model



The QR code provides valuable information on available options for every door series.

- AT 540
- AT 530
- AT 525
- AT 520
- AT 510
- AT 500
- HT 410
- HT 400

Dark grey represents aluminium doors

A door system marked in red represents the depicted door

Brown for timber-aluminium doors

Also available in the listed door systems

MODELL / TYPE	FA	K	H
AT 500	X		
AT 510	X		
AT 520	X	X	X
AT 525	X	X	X
AT 530	X	X	X
AT 540	X	X	X
HT 400	X	X	X
HT 410	X	X	X

Materials to match your requirements

An entrance door is not just used for entering and leaving the house, but also to welcome guests. It is the feature that provides first impressions and reveals a lot about the residents of the home.

Outside

Choice of colours Our extensive range of colours and design options can be found on page 112.

Inside

Diverse

Whether you opt for an aluminium or timber-aluminium door – both look the same from the outside. On the inside, you can choose your preferred material (page 112/113).



Side lights

Every door can be purchased with or without side lights.



House numbers

The house number can be milled into the door panel or sandblasted into the glass of the side light.



Glass options

Internorm offers a wide range of glazing options, including a new range of motif glass. Bespoke glass features are available with technical request.



Handles

A huge selection of handles is available for every door.



Colours & materials

Choose from many different colours and special designs to create your door.



Security

Smart access control systems are available.

What our entrance doors have to offer.

The entrance door is the stand-out feature of your house, which is why Internorm only offers unique, premium doors, that are tailor-made for you to the highest standards. Choose from seven distinct series to create your exclusive door.



Design versions

The respective systems with their various abbreviations (AT 540, AT 530, HT 410, etc.) feature different functionalities and features. In addition, every system comes with its own design, ranging from flush-mounted or angular through to contoured.

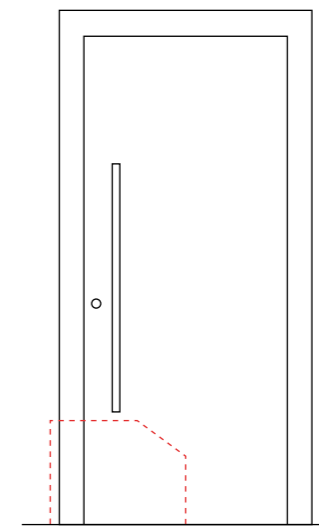

Aluminium entrance doors

Aluminium entrance doors are light, but also exceptionally strong and weather-resistant. Incorporating a 3-chamber frame profile, foam insulation core (or insulating glass core for AT 510), and a thermally broken threshold, it offers optimal thermal insulation.

Timber-aluminium entrance doors

Many customers still want the warm, natural feel of timber on the inside. However, timber is more susceptible to weathering. With an external aluminium panel, the door is protected from harmful weather conditions. Timber also offers very good insulating properties, which is why timber-aluminium entrance doors are perfectly suited to low-energy homes.



Our timber-aluminium entrance doors are a perfect **fit for low-energy and passive houses.**

HT 410

Flush-mounted on the inside and outside



HT 400

Square-edged on the inside and outside

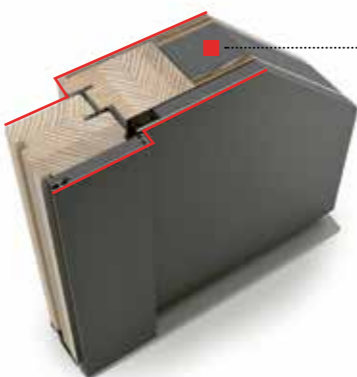

Thermal foam insulation

The material compound of timber, aluminium and thermal foam provides **optimal thermal insulation and energy efficiency.**

AT 540

Flush-mounted on the inside and outside



AT 530

Square-edged on the inside and outside

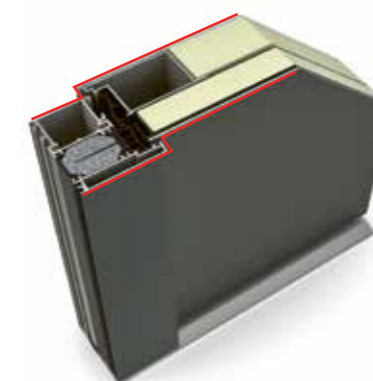

AT 525

Square-edged on inside, flush-mounted on outside



AT 520

Contoured on the inside, square-edged on the outside

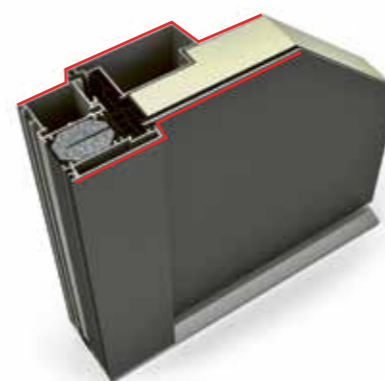

AT 510



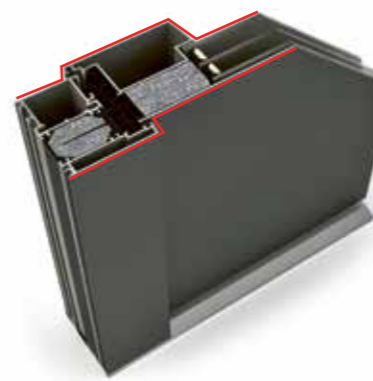

Contoured on the inside, square-edged on the outside



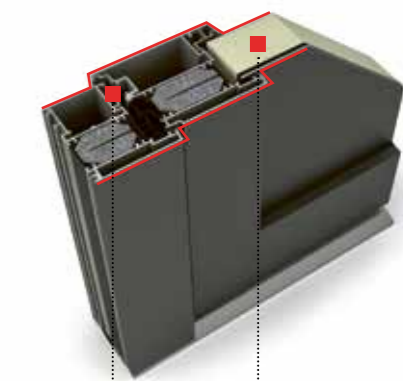



AT 500

Profiled on the inside and outside



-  Thermal insulation
U₀ as low as = 0.67 W/(m²K)
-  Locking
Multiple
-  Noise reduction
up to 34 dB
-  Construction depth
85–121 mm
-  Security
up to RC 2

-  Thermal insulation
U₀ as low as = 0.69–0.95 W/(m²K)
-  Locking
Multiple
-  Noise reduction
32 to 40 dB
-  Construction depth
93 mm
-  Security
RC 2 to RC 3

Optimal thermal insulation

All our aluminium entrance doors feature a **3-chamber frame profile and a foam insulation core** for outstanding thermal insulation (except AT 510 – insulating glass core). The triple gaskets guarantee protection from moisture and cold.

Entrance Door Series

Our entrance door series

Whether you are looking for a door with a solid panel, or one with glass features, Internorm entrance doors offer you a wide range of design styles and material options. Create your very own, unique door to suit your taste and your home's architectural style. Contemporary or traditional, the choice is yours. Here is just an overview of our product range.



Series.V

Internorm

Internorm

Modern meets visionary

Stunning new designs and exceptional quality live up to even the most demanding ideals of modern living. Our new designer doors combine elegance and individuality and will win you over with stylish details.

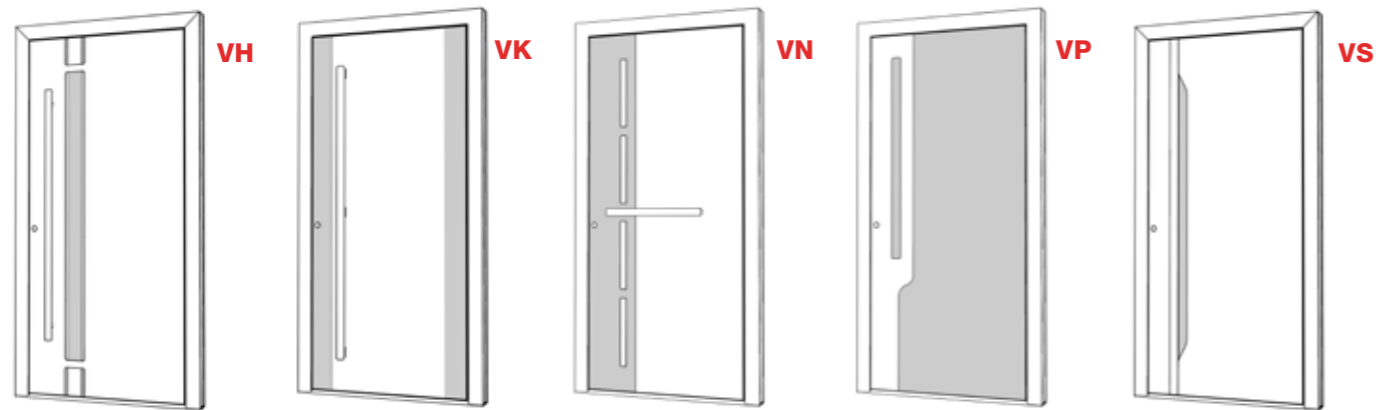
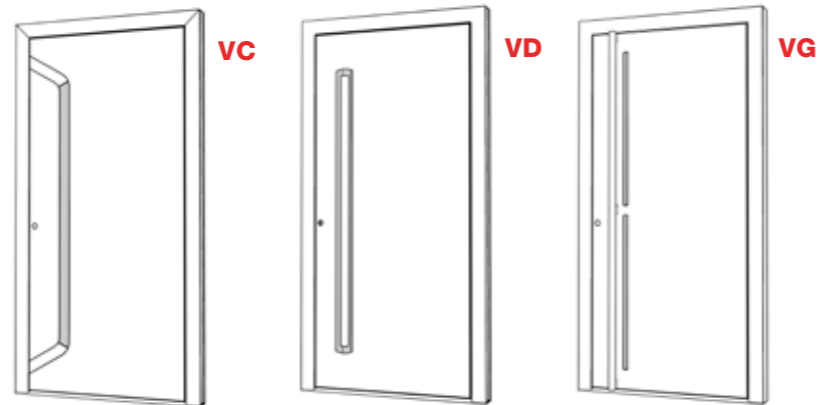

Scan the QR code and find out which door models to combine with which finishes



“You should feel that special sense of home every time you step through your front door!”

Denis Vesel, VESEL design



Designer Denis Vesel created a new design dimension with a new entrance door range for Internorm. He turned his vision of timeless elegance into reality, from the initial idea and designs, to the finished product: “My goal was to create a new dimension of design that people would get excited about. The look of the door should feel natural, be inspiring and turn any entrance into something special!” With simple shapes and lines, Denis Vesel developed a sophisticated designer series that is both elegant and inspiring.

The carefully coordinated design and attention to detail make these premium doors truly unique. Despite the simple shapes, Denis Vesel has developed a real sophistication that comes across as both elegant and exciting. “You should feel that special sense of home every time you step through your front door. For me, it was important to fully tailor the design of the entrance doors to the people, and create an exciting design element, not simply a door”, says the designer.



Design meets timeless elegance



Watch the video with designer Denis Vesel here.

Cleverly positioned glass panes lend this door an elegant touch.



“For me as a designer, the entrance door represents one of the most important design elements!”

Denis Vesel, VESEL design



VD

Colour: RAL 9005
Handle: GSHG black
Order No.: V0001

AT 540 AT 530



VN

Colour: Frame HM712, sash HM712, RAL 9005
Handle: GPR60
Glass: Satinato white
Order No.: V0002

AT 540 AT 530



reddot winner 2023

The visionary door design received the prestigious **Red Dot Award: Product Design 2023** for its timeless elegance, meeting modern requirements for functionality and security.



VG

Colour: Frame RAL 9005, sash SD10
Antique wood
Handle: GKVV black
Order No.: V0003

AT 540 AT 530



VP

Colour: Frame RAL 9005, sash SD03
Art-Concrete, RAL 9005
Handle: GSIV black
Order No.: V0004

AT 540 AT 530



VK

Colour: Frame HM819, sash HM819, RAL 9005
Handle: GPRV black
Order No.: V0005

AT 540 AT 530

NOTE: Special décors (SD colours) are not available for all door systems. Scan the QR code to find details for each series.



VC

Colour: HM906
Handle: GSIV black
Designer panels: black fine structure
Order No.: V0100

AT 540 AT 530



VH

Colour: HM907
Handle: KGS03
Glass: MV11FE
Designer panels: Alunox, black fine structure
Order No.: V0102

AT 540 AT 530



VS

Colour: HM712
Handle: GSIV black
Designer panels: black fine structure
Order No.: V0101

AT 540 AT 530



Solid designer panels

Doors with solid panels look stunning and keep your home private. Create your contemporary entrance door with discreet groove milling and aluminium strips. A choice of straight or recessed handles will add to the overall design to create an impressive and modern entrance area.



Scan the QR code and find out which door models to combine with which finishes

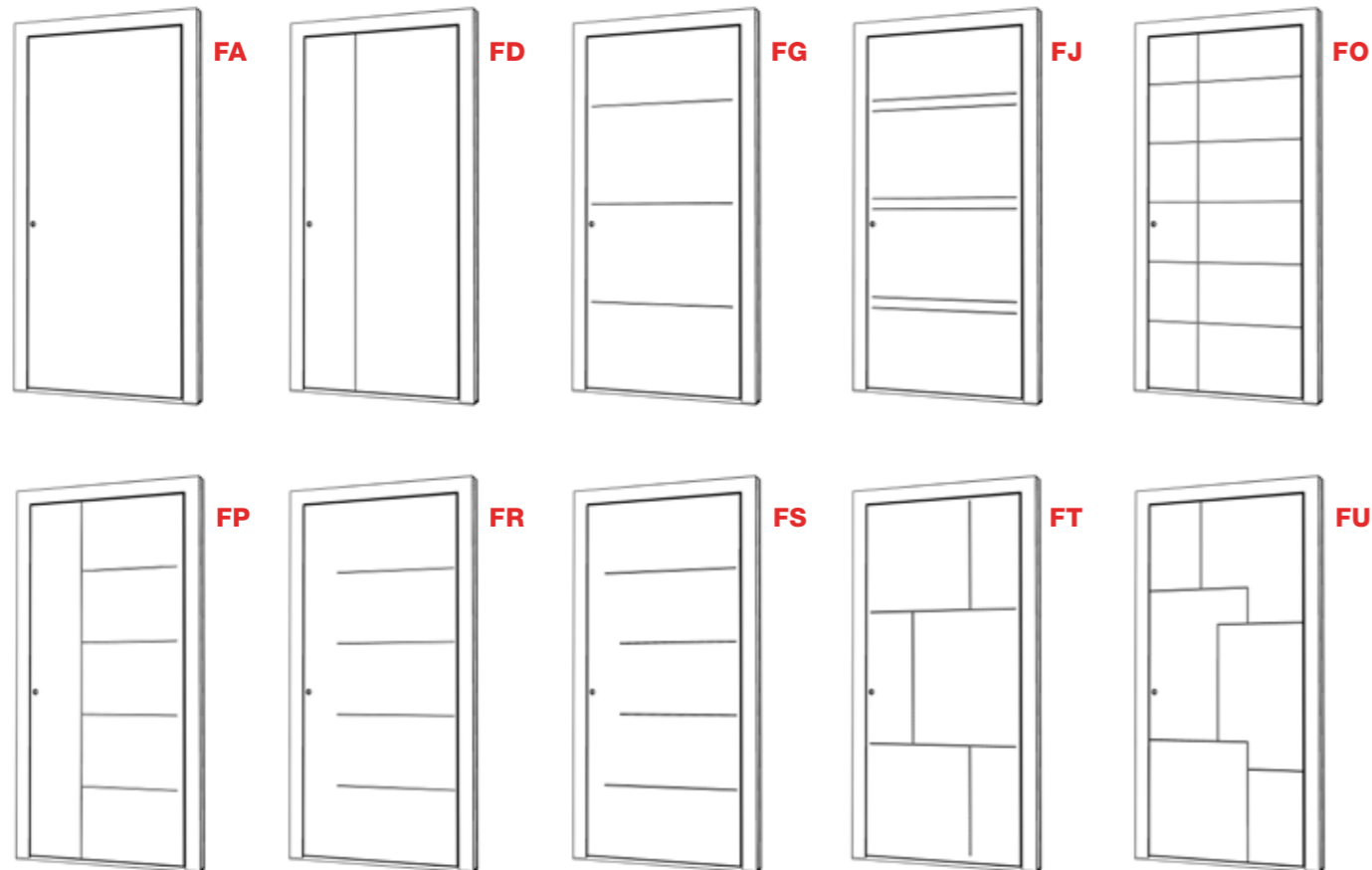

TRENDSETTER

Doors from our 'Art' range are not only striking, they are also unique. Each door has its own individual surface and in combination with aluminium trims or side lights, each of these doors becomes a style focus.

Real timber in antique finish – each door is unique



FA

Colour: Frame RAL 9005, sash SD07 Art-Stone
 Handle: KGS04
 Base profile: Stainless steel 20 mm
 Order No.: F0051

- AT 540
- AT 530
- AT 525
- AT 520
- AT 510
- AT 500
- HT 410
- HT 400



FD

Colour: Frame HM716, sash SD10, HM716
 Handle: RGS05
 Special glass: Dark Grey
 Order No.: F0002

- AT 540
- AT 530
- AT 525
- AT 520
- AT 500
- HT 410
- HT 400

NOTE: Special décors (SD colours) are not available for all door systems. Scan the QR code to find details for each series.



FG

Colour: HFM14
 Handle: EGS01
 Order No.: F0003

- AT 540 AT 530 AT 525 AT 520 AT 500
- HT 410 HT 400



FJ

Colour: Frame RAL 9005, sash SD05 Art-Corten
 Handle: KGS04
 Designer panels: Aluminium trim
 Base profile: Stainless steel 20 mm
 Order No.: F0052

- AT 540 AT 530 AT 525 AT 520 AT 500
- HT 410 HT 400



NOTE: Special décors (SD colours) are not available for all door systems. Scan the QR code to find details for each series.



FR
 Colour: Frame RAL 9005, sash SD08 Art-Basalt
 Handle: GKV03 black
 Designer panels: Aluminium trims
 Base profile: black 20 mm
 Order No.: F0053

- AT 540
- AT 530
- AT 525
- AT 520
- AT 500
- HT 410
- HT 400



FO
 Colour: HM722
 Handle: RGS01
 Base profile: Alunox 20 mm
 Order No.: F0050

- AT 540
- AT 530
- AT 525
- AT 520
- AT 500
- HT 410
- HT 400



FP
 Colour: Frame HM704, sash HM704, M916
 Handle: KGS03
 Order No.: F0006

- AT 540
- AT 530
- AT 525
- AT 520
- AT 500
- HT 410
- HT 400

Black or stainless steel coloured aluminium trims
 lend your door a very special aesthetic.



FS
 Colour: HFM04
 Handle: GSI40
 Designer panels: Aluminium trims
 Order No.: F0008

- AT 540
- AT 530
- AT 525
- AT 520
- AT 500
- HT 410
- HT 400



FT
 Colour: Frame RAL 9005, sash SD09 Art-Carrara
 Handle: SG17 black
 Designer panels: Aluminium trims
 Base profile: black 20 mm
 Order No.: F0054

- AT 540
- AT 530
- AT 520



FU
 Colour: Frame HM716, sash HM712
 Handle: SG13
 Order No.: F0010

- AT 540
- AT 530
- AT 520
- AT 500

NOTE: Special décors (SD colours) are not available for all door systems. Scan the QR code to find details for each series.

Symmetry in balance

This extensive range of doors impresses with its simplicity and symmetry. Whether you opt for a full-length slim glass window or prefer perfectly aligned smaller windows in the centre or the side, the choice is yours.

To create an even more individual entrance door, you can add milled grooves or decorative aluminium trims.

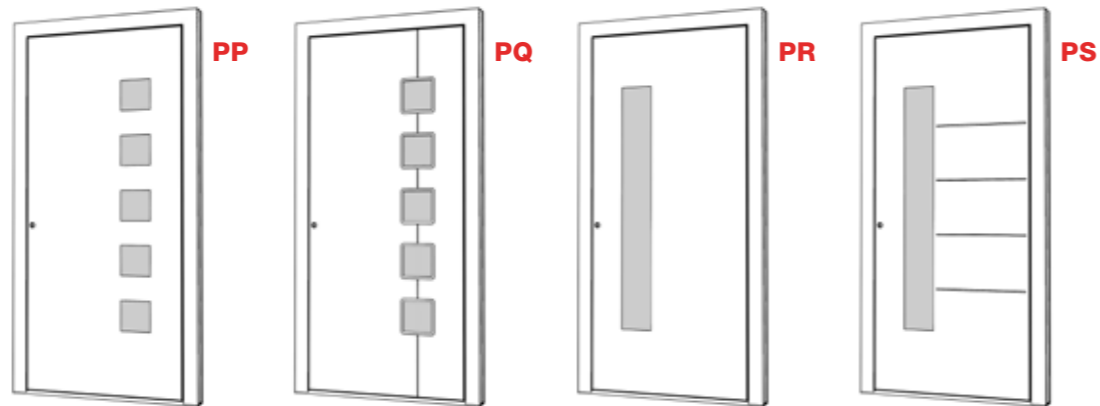
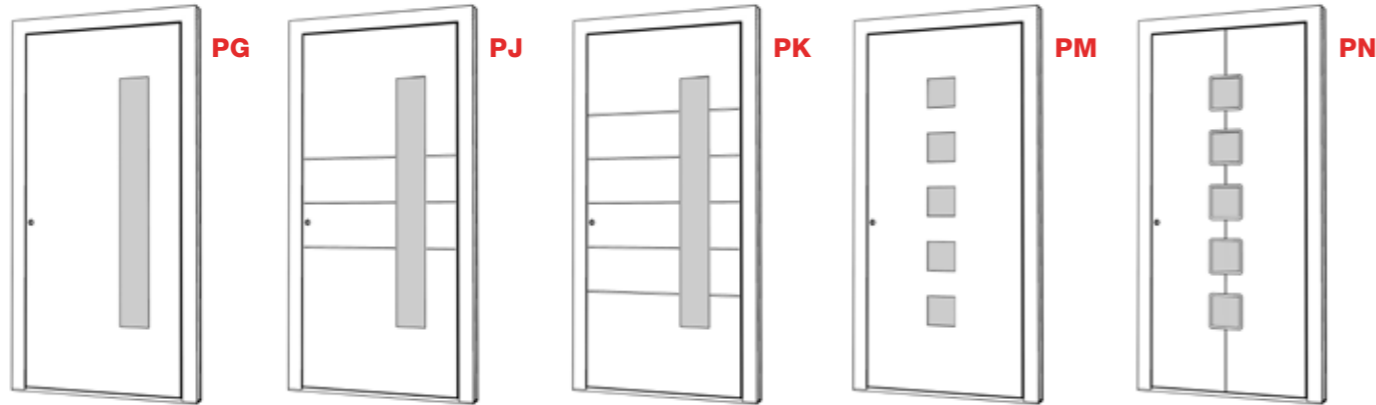
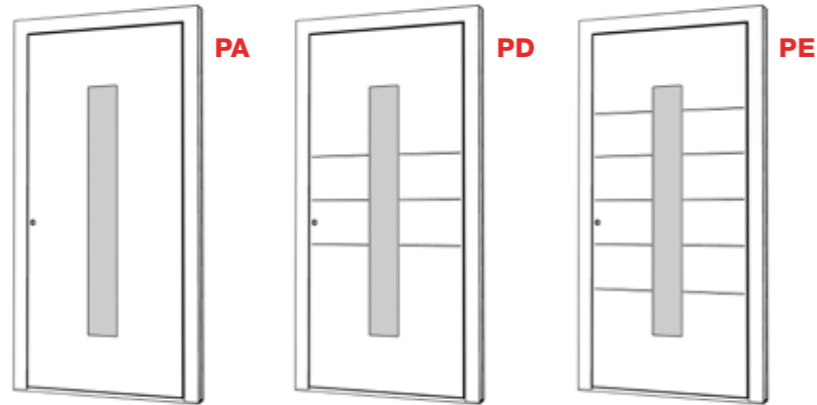

Scan the QR code and find out which door models to combine with which finishes

For selected models, you also have the option of choosing from a range of motif glazing (see page 121).



PA
 Colour: Frame RAL 9005, sash SD10 Antique wood
 Handle: HGS01 black
 Glass: Satinato white
 Order No.: P0001

- AT 540
- AT 530
- AT 525
- AT 520
- AT 510
- AT 500
- HT 410
- HT 400



PD
 Colour: HFM21
 Handle: GSI03
 Glass: Satinato white
 Order No.: P0050

- AT 540
- AT 530
- AT 525
- AT 520
- AT 500
- HT 410
- HT 400

NOTE: Special décors (SD colours) are not available for all door systems. Scan the QR code to find details for each series.

WOW FACTOR

Beautiful doors with textured ceramic surfaces are on trend. They create a feature within any architectural style.

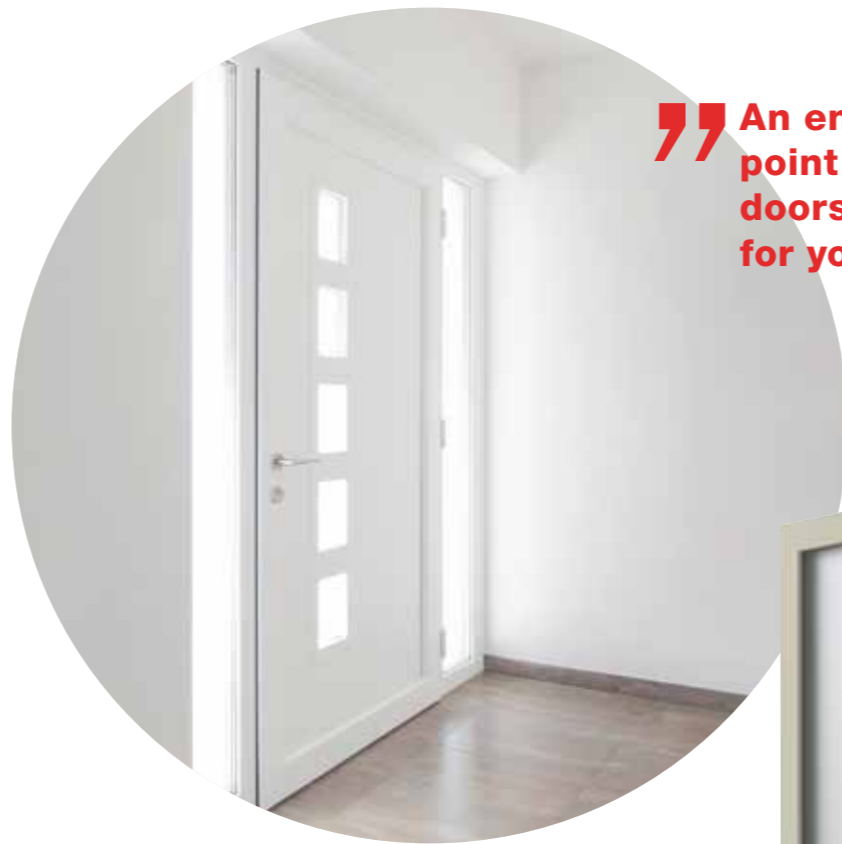

“An entrance door is the focal point of your house, and Internorm doors are bespoke, unique, and made for you to the highest standards.”



PE

Colour: HM716
Handle: EGS01
Glass: Satinato white
Order No.: P0003

- AT 540
- AT 530
- AT 525
- AT 520
- AT 500
- HT 410
- HT 400



PG

Colour: Frame HM721, sash SD06 Art-Steel
Handle: RGS02
Glass: Satinato white
Base profile: Stainless steel 20 mm
Order No.: P0051

- AT 540
- AT 530
- AT 525
- AT 520
- AT 510
- AT 500
- HT 410
- HT 400

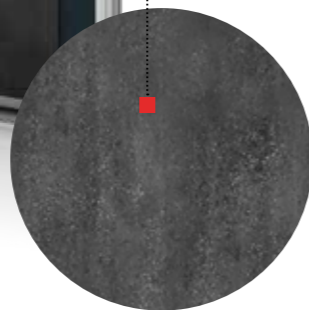

PJ

Colour: HF113
Handle: KGS03
Glass: Satinato white
Order No.: P0005

- AT 540
- AT 530
- AT 525
- AT 520
- AT 500
- HT 410
- HT 400



PK

Colour: M916
Handle: RGS03
Glass: Satinato white
Order No.: P0006

- AT 540
- AT 530
- AT 525
- AT 520
- AT 500
- HT 410
- HT 400

NOTE: Special décors (SD colours) are not available for all door systems. Scan the QR code to find details for each series.



PM

Colour: Frame RAL 9005, sash SD07 Art-Stone
 Handle: KGS05 glass: Satinato white
 Base profile: Stainless steel 20 mm
 Order No.: P0052

- AT 540
- AT 530
- AT 525
- AT 520
- AT 510
- AT 500
- HT 410
- HT 400



PR

Colour: HM716
 Handle: RGS02
 Glass: Satinato white
 Order No.: P0011

- AT 540
- AT 530
- AT 525
- AT 520
- AT 500
- HT 410
- HT 400



PP

Colour: HFM12
 Handle: RGS05
 Glass: Satinato white
 Order No.: P0009

- AT 540
- AT 530
- AT 525
- AT 520
- AT 510
- AT 500
- HT 410
- HT 400



PQ

Colour: Frame HM721, sash HM721, HM907
 Handle: SG18
 Glass: Satinato white
 Order No.: P0010

- AT 540
- AT 530
- AT 525
- AT 520
- AT 500
- HT 410
- HT 400



PN

Colour: Frame HM907, sash HM907, M916
 Handle: GKV03
 Glass: Satinato white Alunox glass surround
 Order No.: P0008

- AT 540
- AT 530
- AT 525
- AT 520
- AT 500
- HT 410
- HT 400



PS

Colour: HM817
 Handle: GSI03 black
 Motif glass: MP43FE
 Order No.: P0012

- AT 540
- AT 530
- AT 525
- AT 520
- AT 500
- HT 410
- HT 400

NOTE: Special décors (SD colours) are not available for all door systems. Scan the QR code to find details for each series.

Discreet and elegant insight

This beautifully designed range focuses on discreet, narrow glass windows and rectangular cut-outs, enhancing the overall appearance. Square or long, slim glass features dominate the design. Milled grooves and decorative aluminium trims add further individual touches.

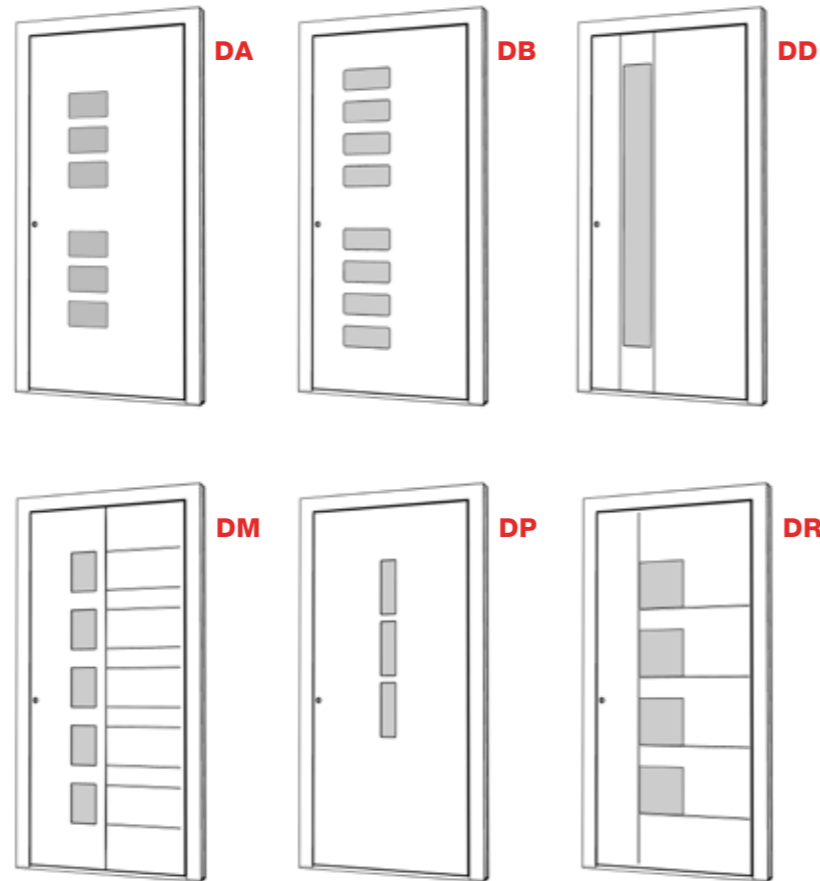

DA

Colour: HM716
 Handle: HS40
 Glass: Satinato white
 Order No.: D0050

- AT 540
- AT 530
- AT 525
- AT 520
- AT 510
- AT 500
- HT 410
- HT 400

DG

Colour: Frame RAL 9005, sash HM704
 Handle: SG17
 Glass: Satinato white, Alunox glass surround
 Base profile: Alunox 20 mm
 Order No.: D0004

- AT 540
- AT 530
- AT 525
- AT 520
- AT 500
- HT 410
- HT 400



Scan the QR code and find out which door models to combine with which finishes



DB
 Colour: Frame HM721, sash SD05 Art-Corten
 Handle: KGS01
 Glass: Satinato white
 Base profile: Stainless steel 20 mm
 Order No.: D0052

- AT 540 AT 530 AT 525 AT 520 AT 510 AT 500
- HT 410 HT 400



DD
 Colour: HM716
 Handle: GOK60
 Glass: Satinato white
 Designer panels: Aluminium trim
 Base profile: Alunox 20 mm
 Order No.: D0003

- AT 540 AT 530 AT 525 AT 520 AT 500
- HT 410 HT 400



DH
 Colour: Frame RAL 9017, sash SD03 Art-Concrete
 Handle: KGS04 black
 Designer panels: Aluminium trim
 Glass: Satinato white
 Order No.: D0005

- AT 540 AT 530 AT 525 AT 520 AT 500
- HT 410 HT 400



DM
 Colour: Frame HFM12, sash HFM12, M916
 Handle: HGS04
 Glass: Satinato white
 Order No.: D0006

- AT 540 AT 530 AT 520 AT 500 HT 410 HT 400



DP
 Colour: M916
 Handle: GD25
 Glass: Satinato white
 Order No.: D0051

- AT 520 AT 500 HT 400



DR
 Colour: Frame RAL 9005, sash SD10 Antique wood
 Handle: HGS03 black
 Designer panels: Aluminium trim
 Glass: Satinato white
 Order No.: D0008

- AT 540 AT 530 AT 520 AT 500 HT 410 HT 400

NOTE: Special décors (SD colours) are not available for all door systems. Scan the QR code to find details for each series.



Focus on glass

With the third series in this range, the emphasis is very clearly on the glass elements. Depending on the model and personal preference, milled grooves and decorative aluminium trims can be added.

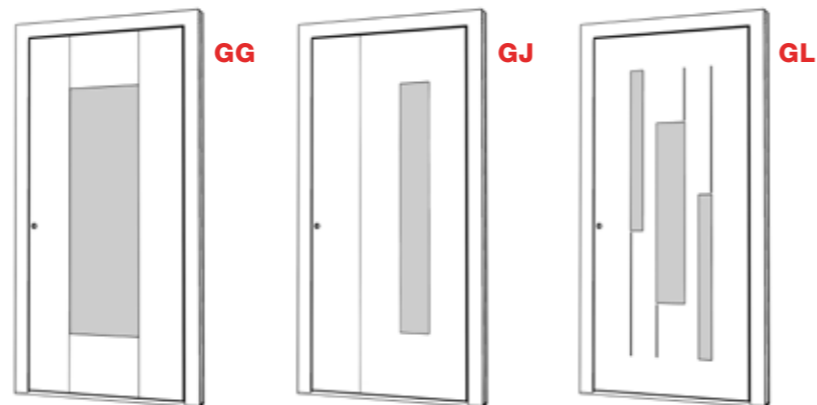
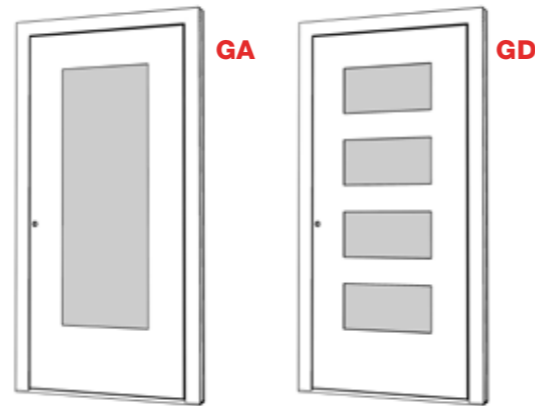

GD

Colour: HFM05
 Handle: KGS04
 Glass: Satinato white
 Order No.: G0100

- AT 540
- AT 530
- AT 525
- AT 520
- AT 510
- AT 500
- HT 410
- HT 400



Scan the QR code and find out which door models to combine with which finishes



GG

Colour: HF113
 Handle: RGS05
 Glass: Satinato white, Alunox glass surround
 Order No.: G0003

- AT 540 AT 530 AT 525 AT 520 AT 500
- HT 410 HT 400



GL

Colour: HM819
 Handle: KGS04
 Glass: Satinato white
 Order No.: G0005

- AT 540 AT 530 AT 525 AT 520 AT 500



GA

Colour: HM716
 Handle: HS42
 Glass: Satinato white
 Order No.: G0001

- AT 540 AT 530 AT 525 AT 520 AT 510 AT 500
- HT 410 HT 400



GJ

Colour: Frame HF735, sash HF735, HF716
 Handle: SG13
 Glass: Satinato white
 Base profile: Alunox 80 mm
 Order No.: G0004

- AT 540 AT 530 AT 525 AT 520 AT 500
- HT 410 HT 400

Bespoke, personalised design solutions

Each door from our different series can be customised to suit your individual requirements. However, Internorm entrance doors offer maximum flexibility. You can add different panels, glass, glazing bars or a mix of all these to create exactly what you want. Your Internorm distribution partner will be happy to advise on the options available.

Illuminated recessed handle

The LED recessed handle from Internorm can be integrated flush into the entrance door.



Illuminated door panel

LED lighting is integrated into the threshold area of the door, creating a well-lit entrance.

Decorative accent lighting

A bright, beautifully lit entrance area creates a warm welcome to both visitors and residents. Adding feature lighting adds drama and atmosphere to your facade.

LED lighting is available for a range of Internorm entrance doors in recessed handles, handle bars or the threshold. It can be fitted with a twilight switch to ensure that lights are turned on automatically at dusk. Connection to a motion sensor is also available.

Mirror, mirror, on the ...

One last look in the mirror before leaving the house – a quick fix of your hair, check your outfit, and you are ready to go.

Internorm offers full-length mirrors for the inside of entrance doors. Virtually flush-mounted to the door sash, they are available in three different colour options to match your door and interior design.

Mirrored doors

are simple, but clever and practical. The mirror can be framed or bonded to the inside. Whatever you choose, you can check your appearance before you leave the house.

Internorm



MOTIF GLASS DESIGN

Colour: HM704
Handle: EGS01
Motif glass: MS71FE
Order No.: X0100

AT 500



MOTIF GLASS DESIGN

Colour: HM721
Handle: EGS01
Motif glass: MF72FE
Order No.: X0101

AT 500



TRANSOM DESIGN

Colour: M916
Handle: HS10
Motif glass: MKR32E
Order No.: X0001

AT 500



TRANSOM DESIGN

Colour: HM704
Handle: RSS06
Glass: Satinato white
Order No.: X0003

AT 500



TRANSOM DESIGN

Colour: HM716
Handle: HS50
Glass: Satinato white
Georgian bars: 97 mm
Order No.: X0002

AT 500



TRANSOM DESIGN

Colour: HM819
Handle: EGS01
Motif glass: MKR32E
Order No.: X0004

AT 500



GEORGIAN BAR DESIGN

Colour: HM817
Handle: HS50
Glass: Satinato white
Georgian bars: 60 mm
Order No.: X0005

AT 500



GEORGIAN BAR DESIGN

Colour: HM722
Handle: HS30
Glass: Satinato white
Georgian bars: 60/40 mm
Order No.: X0006

AT 500



MOTIF GLASS DESIGN

Colour: Frame HM716
Handle: EGS01
Motif glass: Sash MF22FE, side light MF22SE
Order No.: X0007

AT 500



Architect: Spee architecten / Photographer: Ossip van Duivenbode

Side and back entrance doors

Security is not just important for windows and entrance doors. Side and back doors have to offer the same protection. And they have to look good of course.

Side entrance doors serve to close off uninhabited, unheated rooms (e.g. garage, basement storage rooms, etc.). Recent statistics show that burglars usually access houses via a side or back entrance. This makes it all the more important to take preventative measures with the right security features. Internorm offers a range of security hardware systems on request.

Side entrance doors are available in aluminium, uPVC, uPVC-aluminium, as well as timber-aluminium with a wide range of options to customise your door.

Aluminium



AT 500 Panel design
Colour: HM704
Handle: HS10
Order No.: X0008



AT 500 Glass panel design
Colour: HM716
Handle: HS10
Glass: Satinato white
Order No.: X0010



AT 500 Glass design
Colour: Frame M916
Handle: HS10
Glass: Satinato white
Order No.: X0009



AT 500 Glass panel design
Colour: HM735
Handle: HS10
Glass: Satinato white
Order No.: X0011

uPVC & uPVC-aluminium



KF 510



KF 410



KF 320



KF 310

Timber-aluminium



HF 410 / HF 510



HF 410 / HF 510

Our online Door Designer

Every Internorm entrance door is totally bespoke and can be designed to suit your personal taste. Our online Door Designer tool lets you create your dream door at your leisure

Simple,
individual,
online!



You create your very own interior design with furniture, flooring or perhaps wall coverings in different colours or materials – elegant, classic and traditional or modern. Windows and entrance doors no longer play a secondary role in designing your interior spaces. With a variety of finishes and colours to choose from, you can create a very individual living environment.

Internorm's bespoke entrance doors are available in both aluminium and timber-aluminium in a range of design options and made to your requirements.

Take advantage of our **online Door Designer tool** on our website to create your custom door, or let one of our **Internorm distribution partners** advise you.



Try the
Internorm Door Designer here!



Countless design options

Find out more about our extensive range of accessories. Choose from hundreds of colours, handles, glass, sun and insect protection to design your windows, doors and entrance doors for your unique home.

Colours for windows and doors

Colours options of external **aluminium cladding** for windows, as well as internal and **external colours** for entrance doors.

Standard colours*



hiest Colours***



HDS Colours**

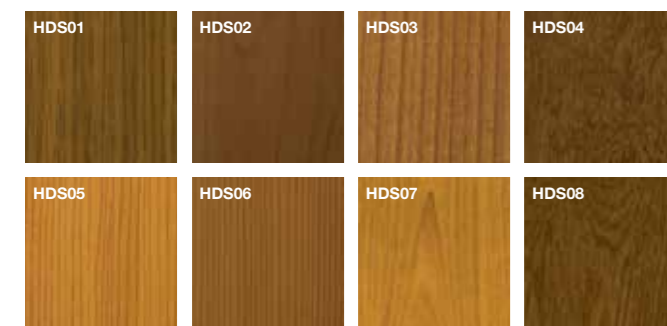

Stainless-steel colours for external window cladding/doors

Stainless-steel colours****



* Highly weather-resistant, except for M916 (facade quality)
 ** Intensive colour, variation possible.
 *** For surface options **HM** (highly weather-resistant standard colour), **HF** (highly weather-resistant fine structure), **HFM** (highly weather-resistant fine structure metallic) a special, highly weather-resistant powder coating is used.
 **** Only possible on both sides of door frame
 ***** Real wood, not suitable for every installation site. Please check with your distribution partner.

Internorm

Special decor for the exterior of entrance doors

SD colours

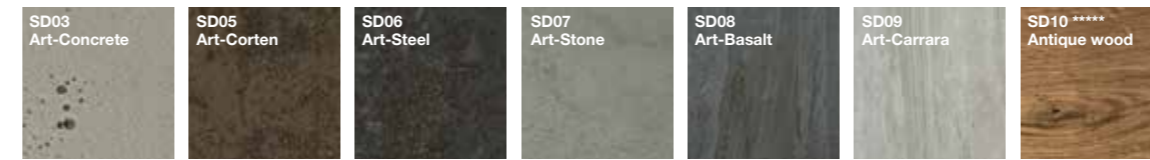

Timber standard colours for the interior of windows and doors

SPRUCE varnished



TIMBER opaque

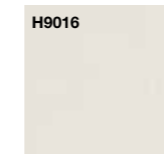

LARCH varnished



WALNUT

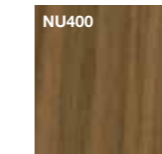

OAK



Special colours

The **Internorm RAL colour programme** offers a range of design options (facade quality). You can choose these colours for the exterior of the aluminium cladding and timber for the interior.

Please note that not every colour is available for every window or door.

Due to printing and manufacturing conditions, colour and structural deviations can occur between the illustrations and the original products.

Your **Internorm distribution partner** will be able to show you the original colour samples.



uPVC for window systems

White

uPVC white

Available for the interior and exterior of all uPVC window systems.

EXCEPTIONS: KF 310 home pure, KF 410 studio, KV 350 and KV 440 are exclusively available as uPVC-aluminium systems

Interior Decor colours	Golden oak	Brilliant white	Cream white	Dark grey
	KF 510			
KF 520				X
KF 310	X	X	X	X
KV 350	X	X	X	X
KF 410 studio		X		X
KF 410 home pure		X		X
KF 410 home soft	X	X	X	
KF 410 ambiente	X	X	X	
KV 440 home pure		X		X
KV 440 home soft	X	X	X	
KV 440 ambiente	X	X	X	
KS 430	X	X	X	X

I-tec Decor Digital printing for uPVC window interior

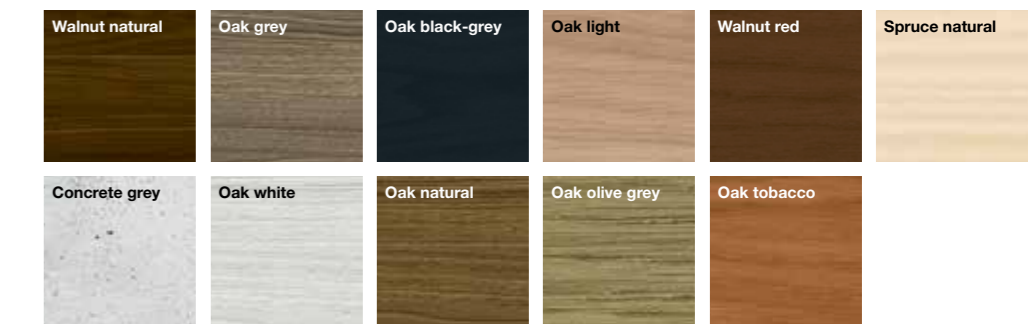

NOTE: I-tec Décor only available for KF 310, KF 410 and KS 430

Add a splash of colour to your life

Windows and doors have become design objects in their own right. Choose colour and create a focal point or seamlessly blend them into the overall architecture.

An overview of our window handle range

The Internorm window handles fit comfortably into your hand and are available as a round, square or flat option. We suggest you start by choosing the handles for your interior decor and then find a matching window handle.

Internorm handle colours

-  F1 aluminium natural
-  F9 aluminium steel
-  RAL 9010 white
-  F9714m black matt
-  Polished brass
-  Chrome with satin finish
-  Chrome/stainless steel matt
-  Brass matt/aluminium steel

NOTE: Not all handle options are available for each window system. Your Internorm distribution partner will be happy to advise you on the combinations available.



Lift & slide door handle G80
Shown in black matt
Item No. 36133

available colours





Lift & slide door handle Dallas
Shown in aluminium natural
Item No. 36424

available colours



Lift & slide door handle Softline
Shown in aluminium natural
Item No. 32447

available colours



Handle G80
Flat key hole cover plate
Shown in aluminium natural
Item No. 36435

available colours



Handle G80
Shown in aluminium natural
Item No. 36404 (Item No. 36505 for KF 310, KF 320, KV 350)

available colours



Handle G80 lockable
Shown in aluminium natural
Item No. 36400

available colours



Handle G80 with push button
Shown in aluminium steel
Item No. 36394

available colours



Secustik® handle G80
Shown in aluminium natural
Item No. 36428

available colours



Secustik® handle Austin flat cylinder key hole cover plate
Shown in black matt
Item No. 36170

available colours





SecuForte® handle
Shown in black matt
Item No. 36132

available colours



Secustik® handle Dallas
Shown in aluminium natural
Item No. 36426

available colours



Standard handle
Shown in aluminium natural
Item No. 33899 (Item No. 36504 for KF 310, KV 350)

available colours





Handle with push button
Shown in aluminium natural
Item No. 33885

available colours



Designer handle Bruxelles
Shown in chrome satin finish
Item No. 34592

available colours



Handle Amsterdam
Shown in aluminium natural
Item No. 36416

available colours



Designer handle Athanai
Shown in brass matt/aluminium steel
Item No. 34594

available colours





Lockable handle
Shown in brass
Item No. 33886

available colours



Designer handle Atlanta
Shown in brass
Item No. 34750

available colours

Our entire entrance door handle range at a glance

Door handles add special detail to the overall design of an entrance door. Internorm offers many options, from recessed, handle bars, to lever handles and more.

Recessed handles

Both attached and flush possible. Only attached option available for AT500, AT520 and AT525.



SG16
Recessed handle, 430x100
Stainless steel
AT500, AT520, AT525, AT530, AT540, HT400, HT410



SG13
Recessed handle, 220x125
Stainless steel
AT500, AT520, AT525, AT530, AT540, HT400, HT410



SG17
Recessed handle, 110x500
Stainless steel, black
AT500, AT520, AT525, AT530, AT540, HT400, HT410

LED lighting available for AT530 and AT540 (see p. 100)



SG18
Recessed handle, 110x1400
Stainless steel
AT500, AT520, AT525, AT530, AT540, HT400, HT410

LED lighting available for AT530 and AT540 (see p. 100)



GSIV Integrated recessed handle

GS140 406 x 59 mm

GS101 1000 x 59 mm

GS102 1200 x 59 mm

GS103 1400 x 59 mm

GSIV Variable length

Respective door panel colour or black AT500, AT520, AT525, AT530, AT540, HT400, HT410

LED lighting available for AT530, AT540, HT400, HT410

Bar handles



HGS01
Half-round bar handle
40x1000
2 supports

HGS02
40x1200
2 supports

HGS03
40x1400
2 supports

HGS04
40x1600
2 supports

Stainless steel, black
AT500, AT520, AT525, AT530, AT540, HT400, HT410



KGS01A
for ekey-dLine square handle bar
40x1000
2 supports

KGS05A
for ekey-dLine square handle bar
40x1800
3 supports

Stainless steel
AT530, AT540, HT400, HT410



KGS01
Square handle bar
40x1000
2 supports

KGS02
40x1200
2 supports

KGS03
40x1400
2 supports

KGS04
40x1600
3 supports

KGS05
40x1800
3 supports

KGS06
40x2000
3 supports

Stainless steel, black
AT500, AT510, AT520, AT525, AT530, AT540, HT400, HT410

KGS01L (not shown)
40x1000
2 supports with integrated LED lighting

KGS03L (not shown)
40x1400
2 supports with integrated LED lighting

Stainless steel AT530, AT540, HT400, HT410



RGS01
Round handle bar
Ø 30
Height 1000
2 supports

RGS02
Height 1200
2 supports

RGS03
Height 1400
2 supports

RGS04
Height 1600
3 supports

RGS05
Height 1800
3 supports

RGS06
Height 2000
3 supports

Stainless steel
AT500, AT510, AT520, AT525, AT530, AT540, HT400, HT410



EGS01
Round handle bar
Ø 35
Variable height

Stainless steel
AT500, AT510, AT520, AT525, AT530, AT540, HT400, HT410



GKV01
Square handle bar with straight ends
30x1000

GKV02
30x1200

GKV03
30x1400

GKV04
30x1600

Stainless steel, black
AT500, AT520, AT525, AT530, AT540, HT400, HT410



RSS01
Round handle bar with diagonal supports
Ø 32
Height 1000
2 supports

RSS02
Height 1200
2 supports

RSS03
Height 1400
2 supports

RSS04
Height 1600
3 supports

RSS05
Height 1800
3 supports

RSS06
Height 2000
3 supports

Stainless steel
AT500



GOK60
Handle bar
Height 600
2 supports
Stainless steel
AT500, AT520, AT525, AT530, AT540, HT400, HT410



GKV60
Handle bar
height 600
2 supports
Stainless steel, black
AT500, AT520, AT525, AT530, AT540, HT400, HT410



GPR60
Handle bar
height 600
2 supports
Stainless steel
AT500, AT520, AT525, AT530, AT540, HT400, HT410

A stylish selection of handles is available for all door series.

Please note that not all handles are available for all doors.

The pictured handles are not in proportion and this page only shows a selection of handles available.

Dimensions are indicated in mm, width x height.

Push and bracket handles



HS10
Push handle
93x400
stainless steel
AT500, AT510,
AT520, AT525,
AT530, AT540,
HT400, HT410



HS50
Push handle
109x500
stainless steel
AT500, AT510,
AT520, AT525,
AT530, AT540,
HT400, HT410



HS40
Push handle
90x500
stainless steel matt
AT500, AT510,
AT520, AT525,
AT530, AT540,
HT400, HT410



HS42
Push handle
90x500
stainless steel
AT500, AT510,
AT520, AT525,
AT530, AT540,
HT400, HT410



PB30
Tubular U-handle
100x300
stainless steel
(PB31 = aluminium
F1) AT500



HS32
Push handle
118x477
Stainless steel
(HS30 = Ring
stainless steel matt)
AT500, AT510,
AT520, AT525,
AT530, AT540,
HT400, HT410



GKN201
stainless steel
AT500

Lever



GD25
Stainless steel, black
AT500, AT510, AT520,
AT525, AT530, AT540,
HT400, HT410



PD12
Brushed aluminium
AT510, AT520, AT525,
AT530, AT540



GD10
Stainless steel
AT500, AT510, AT520, AT525,
AT530, AT540, HT400, HT410



GD15
Stainless steel, black AT500,
AT510, AT520, AT525, AT530,
AT540, HT400, HT410



GD20
Stainless steel
AT500, AT510, AT520, AT525,
AT530, AT540, HT400, HT410



GD30
Stainless steel
AT500, AT510, AT520, AT525,
AT530, AT540, HT400, HT410



SD10
Stainless steel, black
AT510, AT520, AT525, AT530,
AT540, HT400, HT410



SD15
Stainless steel (SD20 = aluminium
natural, SD25 = aluminium white)
AT500, AT510, AT520,
AT525, AT530

Interior designs for doors

You can also create features on the inside of your entrance door - choose between our simple straight or elegantly curved designs. Available in our standard range of aluminium colours for the colour features, with either decorative trim or milled grooves. These can be contrasting, or match the colour of the door panel, making the decorative trim or milling stand out.



Interior design 1

Two flush-mounted trims in black or stainless steel frame the slim, vertical feature area.

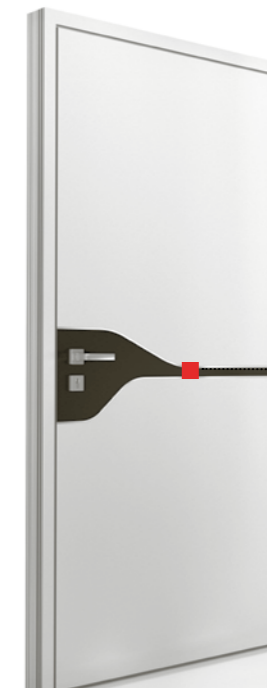
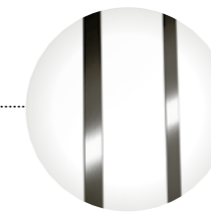

Interior design 2

The feature colour area of this elegant design, which surrounds the door handle, is set within flush-mounted stainless steel trims or milled grooves.

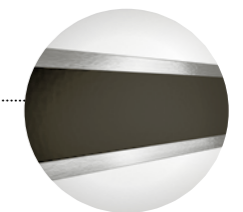

Note: Interior designs are only available for selected models of the AT 540 and AT 530 systems. Your distribution partner will be happy to advise on options.

Milled grooves and metal trims for doors

Simple or impactful. Whatever option you choose, they both offer a unique appeal. The more understated milled grooves blend into the design of your entrance door, whereas trims made of Alunox (flush) or stainless steel (raised) offer visual highlights. Black aluminium trims, available flush or raised, create effective contrast.



Milled grooves

Double milled groove



Metal trims

Metal trims are available as flush in aluminium or raised in stainless steel and black.

Double aluminium strip



Our structured glass for windows and doors



Glass is not easy to display in print and might deviate from the original in both colour and structure. To avoid confusion, please compare the sample glass at your **Internorm distribution partner**.

Condensation – sign of quality: Internorm windows have excellent thermal insulation and air tightness. This not only prevents drafts, it also saves on heating, and keeps out noise. Due to physical conditions, condensation may occur. This might be seen as an issue, however, it is actually a sure sign that the window is performing and offers good thermal insulation properties.

Condensation on the outside: After cold nights, the glass panes can mist up on the outside because good thermal insulation ensures that very little heat escapes from the inside to the outside of the window. This means that the outer pane stays relatively cold and the ambient moisture, caused by the temperature difference between the air and the window surface, can become visible on the cool glass surface in the form of condensation (small water droplets that limit what you can see through the pane). However, this effect only occurs during morning hours and if the window is in a certain position in the house. It disappears again as soon as the temperature rises.

Condensation on the inside: Due to water vapour from kitchens, bathroom or simply breathing, particularly in bedrooms, the humidity of the air increases in interior spaces. If you do not ventilate rooms regularly, this humidity can quickly form as condensation on your windows.

You can find more tips and tricks on how to avoid condensation on our homepage and in the **“Internorm User Manual, Care, Maintenance, Warranties”**.

ESG (toughened safety glass) and insulating glass

Most insulating and toughened safety glass used in Internorm products is made in-house. We are independently driving progress and trying to meet the demand for innovative and highly insulating glass solutions.

Thermal insulation glazing

Wafer-thin stainless-steel coatings and noble gases, such as argon or krypton, are inserted into the space between the panes and provide perfect thermal insulation. If you opt for triple thermal insulation glazing instead of double glazing, you can incorporate 40% more glass areas without increasing your heating costs.

Security glass

If sufficient force is applied to ESG (toughened safety glass), it breaks into blunt-edged, loosely connected crumbs. VSG (laminated safety glass) shatters, but is attached to a tear-resistant, viscoplastic intermediate layer. The risk of injury is therefore very low.



Design glass for doors

A range of techniques such as fluted bevel, sandblasting, glass decorative trim or colour fields are used to create the design glass.

Motif glass for doors

Depending on the desired decorative element, you can decide whether the look is also repeated in the side light or in the glass feature. These feature lines continue from the door itself and are available in different options.

Please note that not every glass can be used with every system.



Clear surface area with sandblasted stripes

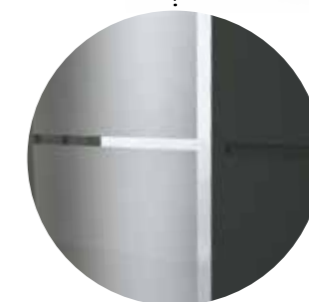

Sandblasted surface area with clear stripes and clear glass edges



Sandblasted surface area with clear stripes

Feel safe and secure

To feel safe and secure in your own home, burglary protection, as well as maximum security for children, are fundamental requirements. Quality windows largely contribute to this feeling of safety. With effective and proven technologies from Internorm, you can protect your family and make it difficult for intruders to enter your home.

Enjoy the benefits of a French balcony.

Create a generous sense of space, even in smaller rooms.

Large-scale glazing is integral to modern architecture. Floor-to-ceiling windows and balcony doors are popular for upper floors. However, balconies or terraces are often not an option in city centres for structural reasons.

Juliet balconies are the perfect solution for letting more light into a room, providing uninterrupted views, and creating beautiful design features. Made with laminated safety glass and stainless steel trim, Internorm's Juliet balconies are factory fitted and uniquely integrated into the window or door frame. Round or square stainless steel bars are also available.

Please ensure that minimum heights comply with Building Regulations to prevent falling.

Different Juliet balcony options:



Glass balustrade option with laminated safety glass, including stainless steel trim



Option with round stainless-steel rail



Option with square stainless-steel rail



Security locks

All Internorm window systems are equipped with standard security hardware. Solid, yet discreet silver-coloured designer locking elements, together with octagonal mushroom cams in the sash, provide secure locking (except KF 510 and KF 520).

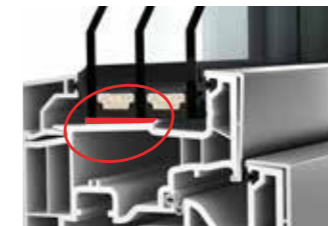

I-tec Glazing

Thanks to Internorm's patented glazing technology, the glass pane cannot be pushed out. The glass is glued into the frame all the way round, making it more secure and stable. Most Internorm window systems include I-tec Glazing as standard.



Security handle

The new Secustik® window handle contains a jamming device that provides integrated security. The patented locking mechanism offers foolproof protection against moving the lock from the outside (standard for the premium-design KF 510 and KF 520 uPVC and uPVC-aluminium windows).



Lockable handles

The window is locked with a key and cannot be opened from the inside or outside. Lockable handles offer optimal security for children and perfect burglary protection.



I-tec Secure/KF 510 and KF 520

The revolutionary locking technology from Internorm guarantees maximum protection. When locking the window, the flaps open and press directly into the interior part of the frame on all sides. It is virtually impossible to lever the window.



Concealed hardware

prevents windows from being levered out of their hinges, with the added benefit of making windows look neat and easy to clean.



Electric opening sensor

Discreet and reliable, these hardwired or wireless locking sensors report whether windows or French doors are open, tilted or locked.



VSG (laminated safety glass)

Unlike standard glass, laminated glass does not shatter when broken. A tough, tear-resistant interlayer, bonded between two glass panes, ensures that the glass stays in the frame and does not cause injury.

Burglar-proof as standard

Proven security locks in our entrance doors ensure that you, your family and belongings are kept safe. Tested up to resistance class RC 3, the high-quality locking systems from renowned manufacturer KfV, provide outstanding burglary protection.



MV

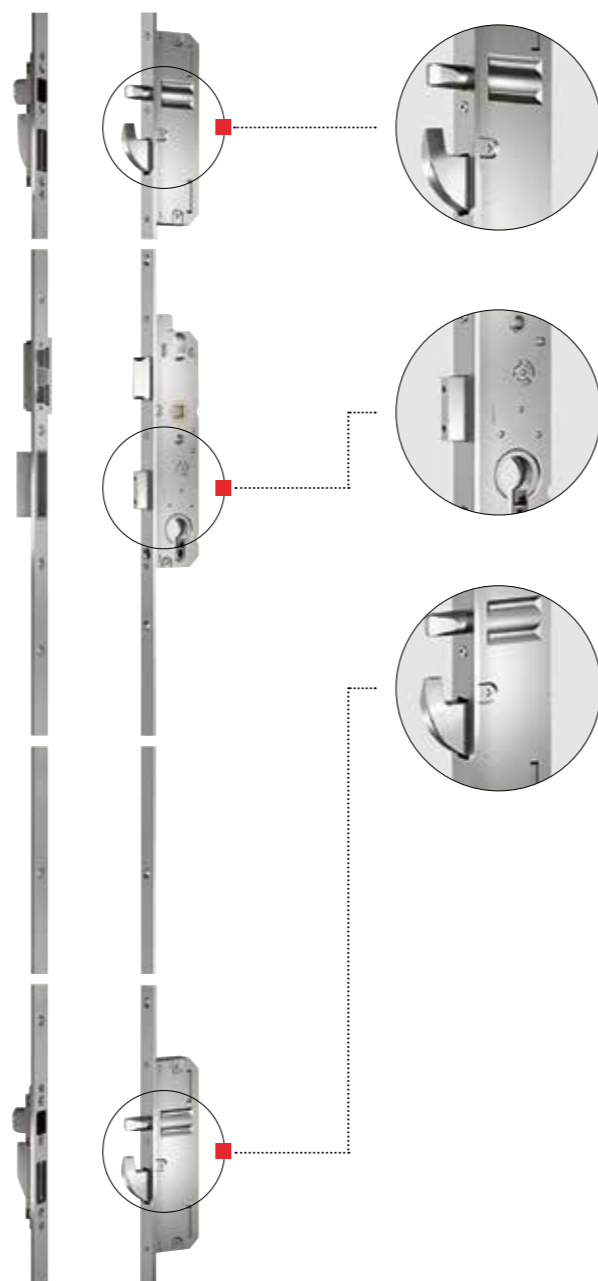

Security as standard

Mechanical: MV

Internorm entrance doors are equipped with a mechanical multi-point lock as standard.

Security as standard

- Multi-point lock = 5-fold protection through a main dead-bolt, 2 steel bolts and 2 swivel latches
- 3 solid door hinges ensure high stability.
- Increased burglary protection is already provided with the standard cylinder (protection against lock picking and drilling)

Comfort as standard

- The soft-lock latch ensures easy operation as well as a gentle close, plus it doesn't require any maintenance (no oil needed)
- Three-dimensionally adjustable door hinges allow you to install the entrance door even more precisely and accurately – with mounted door sash.
- Cylinders that are lockable from both sides – meaning you can always lock them, even if a key is inserted on the other side

Enhanced security and comfort

Automatic: MVAM

Enhanced security with an automatic multi-point lock with main deadbolt, 2 trigger bolts and 2 swivel latches:

- Door mechanically locks automatically – trigger bolts and swivel latch extend through spring force
- Doesn't need to be locked with a key

Semi-motorised: EE

Comfort and security thanks to a semi-motorised multi-point lock with main deadbolt, 2 trigger bolts and 2 swivel latches:

- Door mechanically locks automatically – trigger bolts and swivel latch extend through spring force
- No need to lock or unlock with a key (unlocking through electric drive); on the inside, the door is unlocked by pressing the lever. A child lock function blocks the lever. Can be combined with all access control systems.

Fully motorised: EVE, EVC

The ultimate comfort thanks to a fully motorised multi-point lock with main deadbolt, 2 trigger bolts and 2 swivel latches:

- Door locks automatically – trigger bolts, swivel latch and main deadbolt extend automatically
- Powerful fastening torque of the door sash through the motor
- No key needed to lock or unlock the door (locking and unlocking via the electric drive). On the inside, the door unlocks either by pressing the lever (EVC) or an electric switch (EVE). From the outside, the door unlocks through access controls (e.g. finger scan, etc.).

A note on EVC: Children can also open the locked door at anytime by pressing the lever on the inside and thereby get outside. In this case, opt for an EVE with an electric button that is hidden or in a higher position.

Your finger is the key.

Gone are the days of searching the whole house for your keys – thanks to a fingerprint scanner or keypad. Internorm installs these smart systems on top of or flush-mounted on the door panel, or integrates them into the handle.



instinct
by MACO

Use your smartphone instead of searching for your key – fully electric locking (VEV)

Innovative multi-point locking opens and closes in a fully automatic and completely keyless process.

- Reliable.** Regardless of whether the sash is closed forcefully or only gently – the system will “grip” and lock reliably (sash is “sucked in”). The horsehead-shaped latch prevents the door from springing open.
- Vigilant.** The intelligent intrusion detection system with seven sensors recognises any tampering at a locking point and triggers an alarm – all before the front door has been fully forced open.
- One-of-a-kind.** Would you like to let a neighbour or family member into your home from afar? No problem – you can easily do so by sending them a one-time key.
- Modern.** With no locking cylinder, the door stands out with its clean design. It can be opened conveniently with an app or optionally via fingerprint scanning.
- Functional.** This reliable high-tech product records all operating cycles and system updates, provides status feedback and opens even in the event of a power failure thanks to emergency power bridging.
- Clever.** Full data control via offline system – all permissions are encrypted and are only stored locally at the door.



For entrance doors and lift & slide doors



For entrance doors



For entrance doors



Finger scanner

The latest generation of **ekey dLine** fingerprint scanners conveniently replaces conventional keys. The control unit takes up little space and is securely installed on the entrance door panel or the frame of the lift & slide door. You won't have to worry about forgetting, losing or having your keys, cards or codes stolen.

Simple. Open the door with one touch of your finger. You manage your permissions yourself – no technician or computer required. All you need is the **ekey bionyx** app. **Convenient.** Your finger is the key, meaning you'll always have it “on hand”. The smart software keeps learning every time you use it and recognises growth in children's fingers or user habits.

Secure. Your unique fingerprint is more secure than any key that could be lost or stolen. Manipulating the system from the outside is impossible. Unauthorised third parties cannot gain access to the key.

A scanner makes your entrance door smart . The system can be integrated into your home network via Wi-Fi, enabling countless functions such as remote opening or push notifications when the door is opened. In addition, your finger scanner will always have access to the latest firmware updates and therefore meet the highest security standards.

Keypad

On top of the finger-scanning option, you can also use the more traditional method of entering a code into the keypad. The **ekey home integra keypad** is installed directly in the door panel, so merely the ultra-flat decorative element remains visible.

With this method, you open the door by typing in a freely selectable four to ten-digit code. You can even create a pattern on the touch-sensitive screen, in the same way that many users unlock their smartphones.

You can programme up to 99 codes. This means that every user can have their own access code. This comes in handy when granting access to cleaning staff, for example – you can delete their code at any time and replace it with a new one.



Security with Winkhaus cylinders for windows and doors

You have a wide range of additional components to choose from, such as high-security cylinders, door locks and many more. Find out more from your **Internorm distribution partner**.



The **standard cylinder** features protection against lock picking and drilling by means of steel pins. It can be locked from both sides, meaning you can still lock and unlock the door if there is a key inserted on the other side.

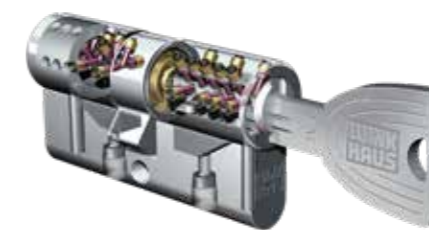

The **high-security cylinder** with three-dimensional, patented protection against lock picking and drilling, as well as pulling and tearing. The large, special key shape makes it easy to lock and prevents the key from bending or breaking. It is lockable from both sides. The symmetrical reversible key is easy to insert into the cylinder.



Every high-security cylinder comes with a personal **security card**. It serves as important proof of legitimacy for follow-up orders of cylinders or keys.

Additional entrance door security options



The **door opening restrictor TSH** serves as a secure opening limiter. You can operate it via the main lock (no cylinder on the outside). The feature is activated from the inside using a turn knob.



For the **electric door opener/ETOE** (normal function), the door can only be opened while there is contact (button is pressed, no permanent contact).

Sun protection and flyscreens

Mix & match, integrated and with many options



Raffstore Venetian blind



External roller shutters



Mini external roller shutters



Windows with integrated blinds



Internal blind



Pull-down flyscreen



Turn/fix frame flyscreen



Sliding flyscreen



Pleated flyscreen



OPTIMA window shutter

By adding sun protection and flyscreen systems to your windows and doors, you can create a more comfortable home and enhance the facade of your building. For ease of operation and convenience, Internorm blind systems can also be connected to smart home systems, such as Loxone or Mediola, and operated via your smartphone or tablet.

Windows with integrated blinds: integrated sun protection and privacy screen between accessible panes – with the option of Venetian, Roman or Duette® blinds, and available with solar powered I-tec Shading on request.

Internal blind: this is mounted onto the window sash and is covered by a housing.

Raffstore Venetian blind: optimum control of light and solar gain with adjustable aluminium slats. Available with RETROLUX daylight control on request; can be combined with flyscreens. Ideal for lift & slide doors.

Exposed Raffstore Venetian blind: optimal control and steering of light and warmth through adjustable slats; can be combined with flyscreens.

External and mini external shutters: loose or fully mounted on the window; can be combined with flyscreens.

Flyscreens: available as fixed, turn, sliding or pull-down flyscreen. Can be combined with blinds.

Pleated flyscreen: space-saving and perfect retrofit solution, also suitable for lift & slide doors.

Window shutters: made of aluminium, with many design options; can be combined with flyscreens.



Raffstore external blinds

Avoid overheating. Reduce costs.

Did you know that smart controlled raffstores can reduce room temperature in summer by up to 10°C compared to unshaded rooms?

Particularly on south-facing rooms it is important to include shading to large areas of glazing to avoid overheating during the summer months. Modern raffstore systems can be integrated into Smart Home systems and help to control solar radiation and light transmission, therefore contributing to passive cooling in summer and solar heating in winter.

Up to 50% less cooling energy

Did you know that cooling a room by 1°C with air conditioning uses three times more energy than increasing heating by 1°C.

Up to 30% less energy consumption

Smart controlled raffstores considerably reduce energy consumption by passive cooling and solar heating.

Reduce electricity costs by up to 80% by not using artificial lighting

Raffstore allow you to control the amount of sun entering your home and the specially designed slats effectively direct daylight into the interior.

Up to 8.5 tonnes of CO₂ saved

One raffstore can save about 8.5 tonnes of CO₂ in its lifetime. The manufacture, use and disposal of a raffstore only creates around 150kg of CO₂.



Colours for sun protection

Venetian blind slats

Standard

RAL 9016 Traffic white	RAL 7035 Light grey	RAL 1015 Light ivory	Beige	RAL 9006 White aluminium
RAL 9007 Grey aluminium	RAL 7016 Anthrazite grey	DB 703 Grey	RAL 9005 Jet black	

Standard longer delivery

RAL 7038 Agate grey	RAL 7039 Quartz grey	RAL 7006 Beige grey	RAL 7021 Black grey	RAL 7022 Umbra grey
Light bronze Classic 32	Medium bronze Classic 33	Dark bronze Classic 34	RAL 6005 Moss green	

Roller shutter

white	grey	beige	cream	Grey aluminium
Aluminium-natural	DB703 Aluminium-grey	Aluminium-anthrazite grey	Aluminium-deep black	Aluminium-brown
Aluminium-moos green	Aluminium-wood dark			

Integrated & internal blinds (Venetian)

0205 milk	0152 crystal	0605 sapphire	0958 moonstone	7010 silver	7113 aluminium	4448 cream	4449 cortina
5056 burgundy red	4808 topaz	4768 praline	4161 messina	4049 genua	4249 torino	2263 indigo	2371 gentian blue
3763 fern green	3251 fir						

Duette®

2340 cloud	2342 dolphin grey	2345 fog	2341 winter white	2346 oyster	2327 dark blue	2337 royal red
------------	-------------------	----------	-------------------	-------------	----------------	----------------

Venetian blind

E001 white	E819 cream	E831 melon	E800 yellow	E802 orange	E839 kiwi	E811 light blue	E816 grey
------------	------------	------------	-------------	-------------	-----------	-----------------	-----------



Technical overview – window

uPVC



KF 310 **KF 320** **KF 410** **KF 510** **KF 520**

Thermal insulation in W/(m²K)					
Standard coating	U _w = 0.76	U _w = 0.72	U _w = 0.71	U _w = 0.71	U _w = 0.70
Optimum value	U _w = 0.69	U _w = 0.65	U _w = 0.62	U _w = 0.63	U _w = 0.63
Noise reduction (in dB)	33 – 45	34 – 45	34 – 47	34 – 46	33 – 46
Security up to	RC 2	RC 2	RC 2	RC 3	RC 3
Locking	Concealed	Concealed	Concealed	Fully integrated	Fully integrated
Measurements in mm					
Frame construction depth	71	71	90	90	90
Sightline – frame/sash	107	97	113	95	85
Sightline – flying mullion (two sashes)	119	100	133	100	96
Sightline – mullion (2 sashes)	170	154	187	147	148
Designs					
Fixed	X	X	X	X	X
Turn and Tilt & Turn	X	X	X	X	X
Tilt	X	X	X	X	X
Sliding window	X	X	X	X	X
Lockable doors	X	X	X	X	X
Lift & Slide doors	X	X	X	X	X
Doors with low threshold	X	X	X	X	X
Outward opening doors	X		X	X	
Gaskets					
Quantity	3	3	3	3	3
Colour external gasket	Light grey	Light grey	Light grey	Light grey	Light grey
Georgian bars					
Integrated	X	X	X	X	X
Surface-mounted	X		X	X	
Available in Design Styles		studio	home pure home soft ambiente	home pure	studio
More info on page	32	30	28	26	24

uPVC-Aluminium



KF 310 **KF 320** **KF 410** **KF 510** **KF 520** **KV 350** **KV 440**

Thermal insulation in W/(m²K)							
Standard coating	U _w = 0.76	U _w = 0.72	U _w = 0.71	U _w = 0.72	U _w = 0.70	U _w = 1.0	U _w = 0.77
Optimum value	U _w = 0.69	U _w = 0.65	U _w = 0.62	U _w = 0.64	U _w = 0.63	U _w = 0.79	U _w = 0.64
Noise reduction (in dB)	33 – 45	34 – 45	34 – 47	34 – 48	33 – 46	38 – 44	39 – 45
Security up to	RC 2	RC 2	RC 2	RC 3	RC 3	RC 2	RC 2
Locking	Concealed	Concealed	Concealed	Fully integrated	Fully integrated	Concealed	Concealed
Measurements in mm							
Frame construction depth	74	74	93	93	93	74	93
Sightline – frame/sash	107	97	113	95	85	112	118
Sightline – flying mullion (two sashes)	119	100	133	100	96	130	144
Sightline – mullion (2 sashes)	170	154	187	147	148	181	198
Designs							
Fixed	X	X	X	X	X		
Turn and Tilt & Turn	X	X	X	X	X	X	X
Tilt	X	X	X	X	X	X	X
Sliding window	X	X	X	X	X		
Lockable doors	X	X	X	X	X		
Lift & Slide doors	X	X	X	X	X		
Doors with low threshold	X	X	X	X	X	X	X
Outward opening doors	X		X	X			
Gaskets							
Quantity	3	3	3	3	3	3	3
Colour external gasket	Light grey/black	Light grey/black	Light grey/black	Light grey/black	Light grey/black	Light grey/black	Light grey/black
Georgian bars							
Integrated	X	X	X	X	X	X	X
Surface-mounted	X		X	X		X	X
Available in Design Styles	home pure home soft ambiente	studio	studio home pure home soft ambiente	home pure	studio	home pure home soft ambiente	home pure home soft ambiente
More info on page	32	30	28	26	24	49	48

Timber-Aluminium



HF 410 **HF 510** **HV 450**

Thermal insulation in W/(m²K)			
Standard coating	U _w = 0.71	U _w = 0.72	U _w = 0.97
Optimum value	U _w = 0.65	U _w = 0.65	U _w = 0.62
Noise reduction (in dB)	33 – 45	35 – 44	41 – 46
Security up to	RC 2	RC 2	RC 2
Locking	Concealed	Concealed	Concealed
Measurements in mm			
Frame construction depth	85	85	85
Sightline – frame/sash	108	99	108
Sightline – flying mullion (two sashes)	124	106	124
Sightline – mullion (2 sashes)	173	156	173
Designs			
Fixed	X	X	
Turn and Tilt & Turn	X	X	X
Tilt	X	X	X
Sliding window	X	X	
Lockable doors	X	X	
Lift & Slide doors	X	X	
Doors with low threshold	X	X	X
Outward opening doors	X		
Gaskets			
Quantity	3	3	3
Colour external gasket	Black	Black	Black
Georgian bars			
Integrated	X	X	X
Surface-mounted	X	X	X
Available in Design Styles	studio home pure home soft ambiente	home pure	home pure home soft ambiente
More info on page	40	38	50

Technical overview – entrance doors

Lift & slide doors and fixed glazing



KS 430 HS 330 HX 300

Thermal insulation in W/(m²K)			
Standard coating	U _w = 0.68	U _w = 0.73	U _w = 0.74
Optimum value	U _w = 0.64	U _w = 0.73	U _w = 0.74
Noise reduction (in dB)			
	33 – 43	32 – 40	34 – 47
Security up to			
	RC 2	RC 2	–
Locking			
	–	–	–
Measurements in mm			
Frame construction depth	200/203	209	100
Sightline – frame/sash	169	178	108
Sightline – flying mullion (two sashes)	173	222	–
Sightline – mullion (2 sashes)	–	–	91.8/111.8
Designs			
Fixed		x	x
Turn and tilt & turn			x
Tilt			x
Sliding window			
Lockable doors	x	x	x
Lift & Slide doors			
Doors with low threshold	x	x	x
Outward opening doors			
Gaskets			
Quantity		2/3	
Colour external gasket	Light grey/black	Black	
Georgian bars			
Integrated	x	x	
Surface-mounted	x		
More info on page			
	54	55	56

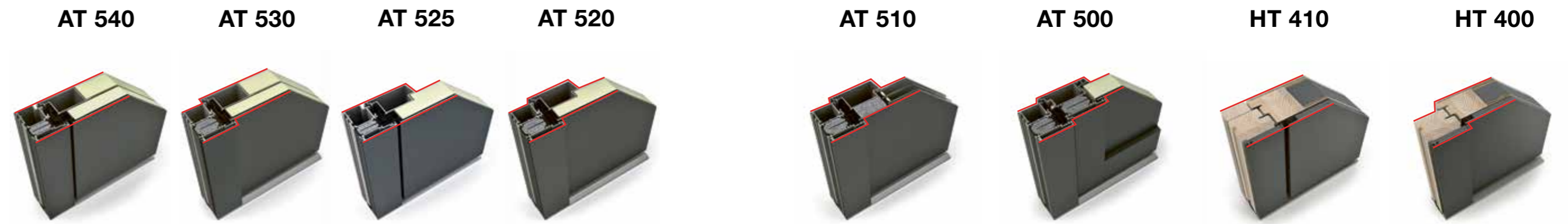
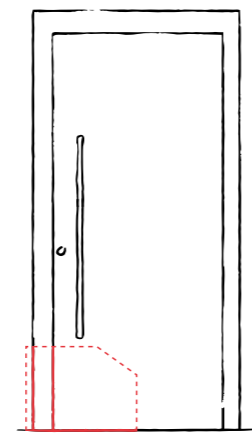

Material	Aluminium	Aluminium	Aluminium	Aluminium	Aluminium	Aluminium	Timber-Aluminium	Timber-Aluminium
Design	Flush inside and outside	Square-edged on inside and outside	Square-edged on inside, flush-mounted on outside	Profiled on inside, square-edged on outside	Profiled on inside, square-edged on outside	Profiled on inside and outside	Flush inside and outside	Square-edged on inside and outside
Thermal insulation in W/(m²K)	U _b up to 0.75	U _b up to 0.69	U _b up to 0.87	U _b up to 0.80	U _b up to 0.95	U _b up to 0.91	U _b up to 0.55	U _b up to 0.67
Noise reduction in dB	Up to 36	Up to 36	Up to 33	Up to 33	Up to 39	Up to 39	Up to 34	Up to 34
Security	Up to RC 2	Up to RC 2	Up to RC 2	Up to RC 2	Up to RC 2	Up to RC 3	Up to RC 2	Up to RC 2
Locking	Multi-point locking	Multi-point locking	Multi-point locking	Multi-point locking	Multi-point locking	Multi-point locking	Multi-point locking	Multi-point locking
Profile construction depth in mm	93	93	93	93	93	93	121	85
Gaskets	3	3	3	3	3	3	3	3
Threshold	Thermally broken	Thermally broken	Thermally broken	Thermally broken	Thermally broken	Thermally broken	Thermally broken	Thermally broken
Insulation	3-chamber frame profile, insulating foam core	3-chamber frame profile, insulating foam core	3-chamber frame profile, insulating foam core	3-chamber frame profile, insulating foam core	3-chamber frame profile, insulating glass core	3-chamber frame profile, insulating foam core	Thermal foam insulation	Thermal foam insulation

National and international certifications affirm the high quality of our products.

Internorm's wealth of experience and focus on innovative technical solutions ensure that you receive the best product and service. State-of-the-art production facilities and stringent quality controls ensure that our product sets industry standards. Prestigious awards and certifications from leading European test institutes support this.



Austrian coat of arms



Austria quality mark



TÜV ISO 9001



TÜV ISO 14001



RAL quality mark



Technische Universität Graz



Minergie® certificate



Austrian Society for Environmental Engineering



Certificate for products from sustainable forestry



QUALITÄTS FENSTER
MADE IN AUSTRIA



Energy Globe
(Project Schiesthaus)



VinylPlus-Zertifikat

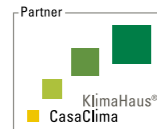

KlimaHaus-Zertifikat



reddot winner 2023



IMPRINT

Publisher: Internorm International GmbH, Ganglgutstraße 131, A-4050 Traun

Photos: Studio Hofflehner, A-4600 Wels | studio46, A-4863 Seewalchen am Attersee | EOS Werbefotografie, A-4020 Linz
Bernhard Hörtnagl, A-6020 Innsbruck | Internorm International GmbH, A-4050 Traun

Design and litho: Internorm International GmbH, A-4050 Traun

Print: Hague Group, Leicester, LE19 4SD

Subject to technical changes, printing and typesetting errors.

Internorm International GmbH is an ARA licence partner: Our licence number is 4477.

HEAD OFFICE

Internorm Windows UK Ltd

Unit D · Colindale Business Park
2–10 Carlisle Road · London, NW9 0HN
Tel.: +44 (0) 208 205 9991
Email: office@internorm.co.uk

uk.internorm.com
commercial.internorm.com

